

T2 Plus User Manual

Yaber
PROJECTOR

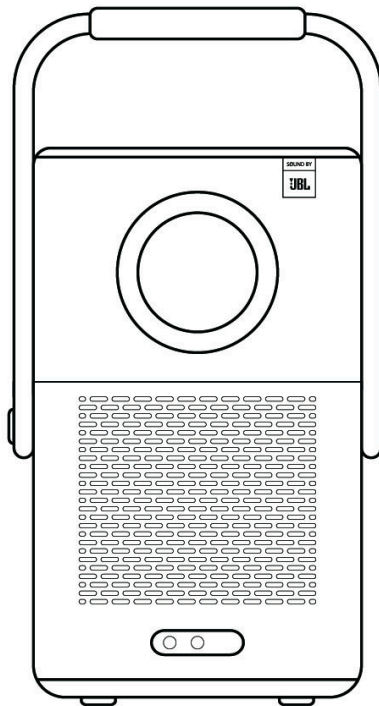

User Manual

Smart Projector T2 Plus

EN

Catalog

Catalog

Catalog	-----
1. YABER Lifetime Professional Support	-----
2. WARRANTY	-----
3. Important Precautions	-----
4. What's included	-----
5. Specification	-----
6. About Battery	-----
7. Installation	-----
8. Projection Settings	-----
9. Picture Settings	-----
10. Connectivity	-----
11. T2 Dongle (Special for T2 Plus or Purchase sep...	-----
12. Bluetooth Settings	-----
13. System Upgrade	-----
14. Quite Mode	-----

1. YABER Lifetime Professional Support

Dear Valued Customer,

Thank you for choosing Yaber T2 projector.

This manual will help you navigate through all the features.

We understand that there may be many questions and concerns that arise during the use of the projector. We are also eager to hear your feedback. However, leaving a review on the product page does not get the fastest solution. Many common problems, such as

inability to auto focus or keystone, sound issues, WiFi or Bluetooth connection issues, can usually be resolved with appropriate settings adjustments.

If you encounter any issues, feel free to send your **order number** and **the problems** to us at service@yaber.com (e.g. **US+T2+000-0000000-0000000+Issues**) Rest assured, our service team will offer a solution to you within 24 hours.

Your satisfaction is our top priority. If you encounter any issues, we sincerely hope you can give us an opportunity to make things right.

We wish you have an outstanding experience with the T2 projector.

Yaber Consumer Service Team

2. WARRANTY

Thank you so much for your purchase and support. We provide 3-year warranty for Yaber T2 projector.

If you have any questions, please feel free to contact us.

For T2 Projector: service@yaber.com

3. Important Precautions

Please use the device correctly:

- Do not face the lens into eyes because the strong projector light may cause injury to the eyes.
- Do not block the air inlet/outlet of the device in order to avoid damage to internal electronic devices arising from normal heat dissipation failure.
- Do not wipe the lens directly with cleaning tools including paper and cloth to avoid damage to the lens, Please clean up the dust on the lens through clean air blowing.
- Do not wash the device with chemicals, detergents, or any liquid to prevent the circuit board from being corroded by rainwater, or moisture mineral-containing liquids.
- Keep the device and its components and accessories out of reach of children.
- Make sure that the device is used in a dry and ventilated environment.
- Do not store the device in excessively hot or cold places, because extreme temperatures will shorten the life of electronic devices. Place and use the device in an environment of 0°C-40°C

- Do not put the device into any heating equipment (such as a dryer and microwave oven) for drying.
- Do not firmly extrude the device or place barriers on it or its back to avoid damage to the device.
- Do not throw, strike, or sharply vibrate the device to avoid damage to the internal circuit board
- Do not try to disassemble and assemble the device yourself. If any issue occurs, please contact the after-sales service of Yaber.

4. What's included

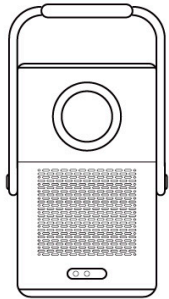

Projector



Remote Control
(For T2)

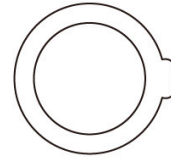

Lens Cover



QSG & FAQ

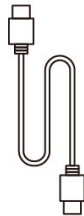

HDMI Cable

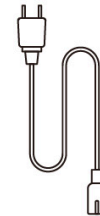

Power Cord

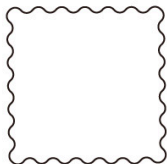

Cleaning Cloth

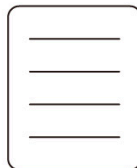

Brand Card

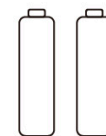

AAA Batteries

If you don't have batteries for the remote control, please contact service@yaber.com.

4.1 Projector Interface

⚠ Notice: Press power button 2s-5s to boot the projector

⚠ Notice: Please ensure that the area in front of the [Focus receiver] is not blocked, otherwise the focus function will be affected.

4.2 Remote Control

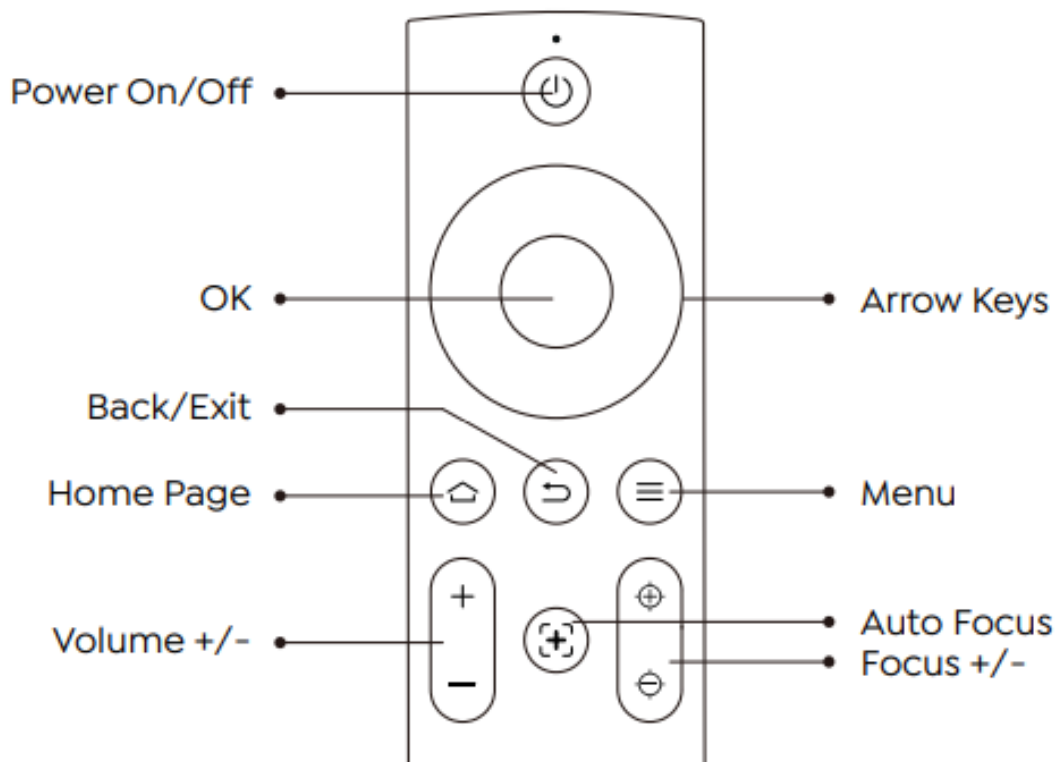

5. Specification

Model No. T2			
Native Resolution	1920*1080	Light Source	LED
Battery Lifespan	Video Playtime 2.5h Music Playtime 18h	Aspect Ratio	16:9/4:3

Focus	Auto/Eletric	Keystone Correction	Auto/Eletric
Screen Alignment	Auto	Obstacle Avoidance	Auto
Interface	USB 2.0*1 HDMI 1.4*1 Audio Out*1 Lan*1	Unit Dimension	165*140*290 mm 6.4*5.5*11.4 inches
Projection Ratio	1.25:1	Projection Distance	Min1.1m~ Max3.3 m Min43.3~Max129.9 inches
Power Voltage	100-240V ~ /50-60Hz	Power Consumption	110W
Projector Weight	2.5 kg 5.5 lbs	Projection Method	Front/Rear on Desk Front/Rear on Ceiling
Picture Format	JPG、 PNG、 BMP、 JPEG		
Audio Format	MP3, AAC, LPCM, APE, FLAC, OGG, AMR		
Video Format	MP3, AAC, LPCM, APE, FLAC, OGG, AMR		
USB Format	FAT 32, NTFS ⚠️Unsupported format: Exfat ⚠️Attention : If the projector cannot recognize the contents of the USB flash drive, please check whether your USB flash drive is formatted correctly.		
WPS Documents	txt, pdf, docx, xlsx. pptx		

6. About Battery

The Yaber T2 is equipped with a battery that will give you 2.5 hours of use in battery mode (Brightness in 60) .

In battery mode, the brightness of the screen will be reduced, thus extending a longer battery life.

You can also adjust the settings to increase the brightness of the screen, but the duration will be shortened.

🔔Tips: (As the number of times the machine is used increases, the battery life may be affected.)

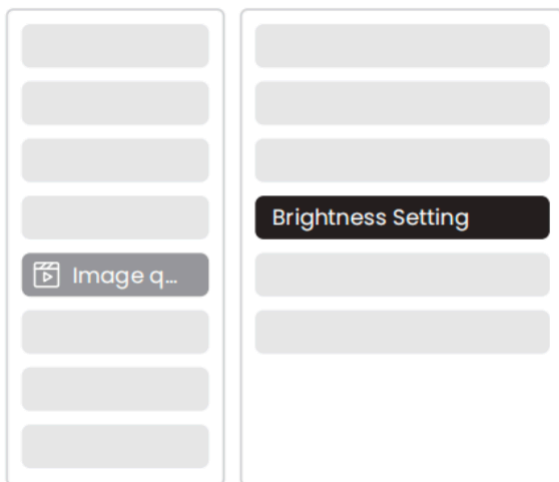

6.1 Charging Time

🔔Tips: For the health of the battery and your experience, we recommend that you charge your machine while it is turned off.

🔔Tips: For first-time use, we recommend you fully charge your projector using the provided power cord.

When the machine is turned off, the charging time from 0 to 100 is **3.5 hours**.

When the machine is turned on, the charging time from 0 to 100 is **5.5 hours**.

From 0% ~ 100%	
Projector turned off	3.5 Hours
Projector turned on	5.5 Hours

When the Power light is **Blue**, it means the battery is completely charged.

When the Power light is **Red**, the battery is charging.

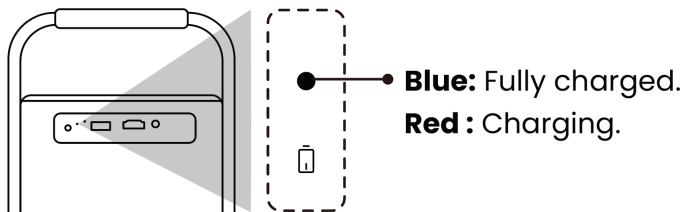

Low Power Notification

When the battery power is lower than 20%, the system will pop up a window to prompt you to charge the Projector. The battery icon on the projector screen will change to:



If the battery is about to run out, the system will push a shutdown countdown pop-up.

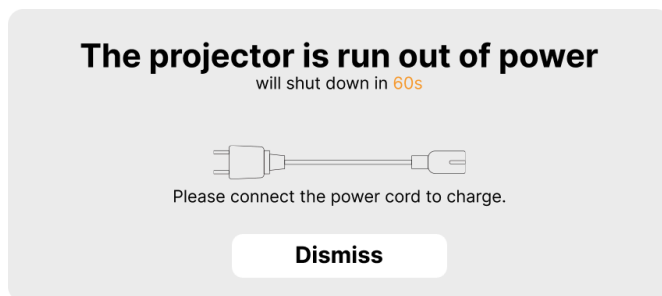

7. Installation

7.1 Handle to Stand

For a better image, please try to place the projector on a stable, flat surface.

If you need to adjust the screen at a larger angle, you can rotate the carrying handle to the bottom and it will provide you with support at certain angles (15%).

⚠ Notice: Please ensure that the area in front of the focus receiver is not blocked, otherwise the focus function will be affected.

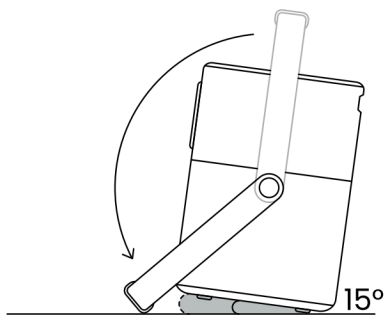

7.2 Ceiling Mounting

⚠ Note: T2 does not support four-corner mount installation.

Step 1: Make sure you have a universal mounting bracket that can fit the projector.

Step 2: Use the stand with **M5*5mm** screw to fix the projector on the bracket to complete the installation.

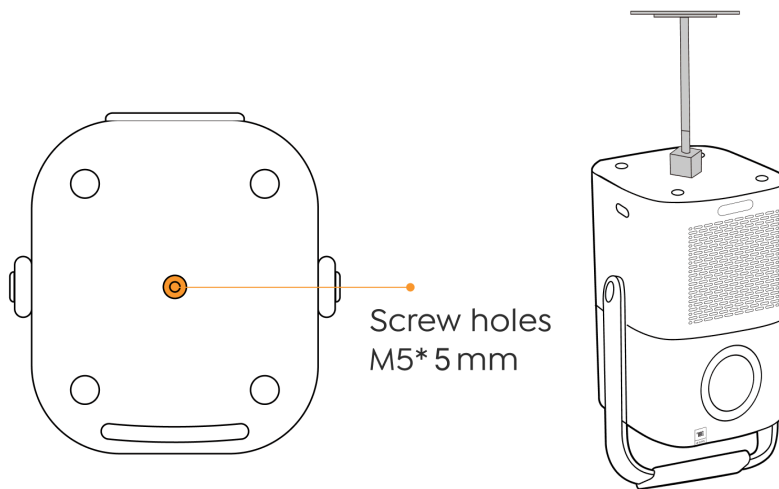

7.3 Stand Mounting

⚠ Note: T2 does not support four-corner mount installation.

Step 1: Make sure you have a universal mounting bracket that can fit the projector.

Step 2: Use the stand with **M5*5mm** screw to fix the projector on the bracket to complete the installation.

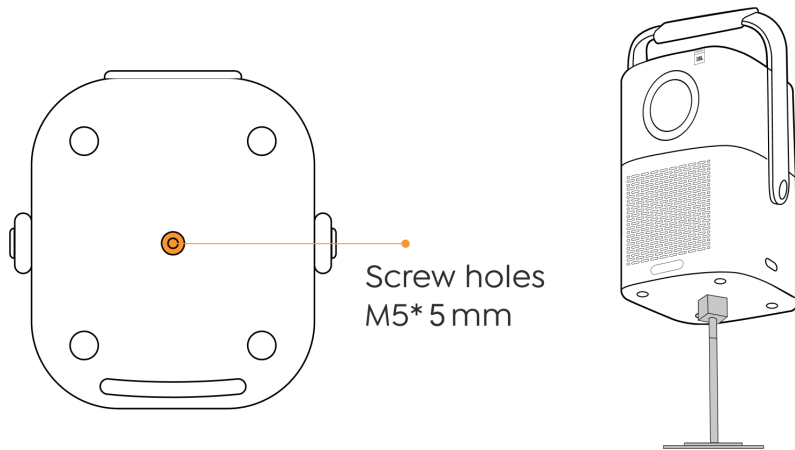

8. Projection Settings

You can select [Settings]- [Image Settings] or [Projection Settings] in to adjust the projector image.

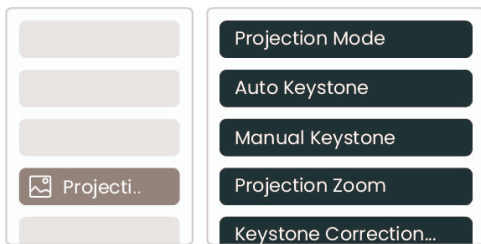

8.1 Projection Distance

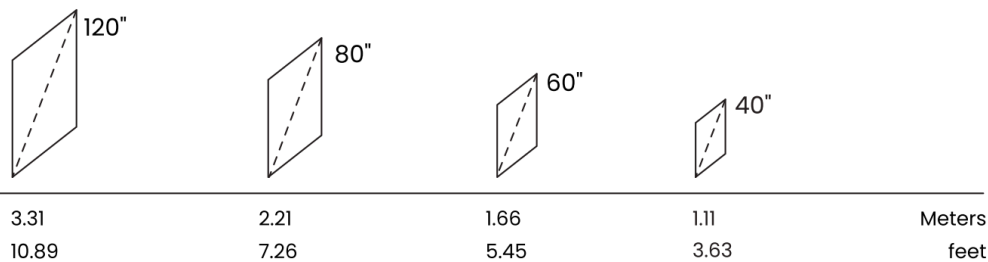

Tip: The recommended Screen size is 80 inches.

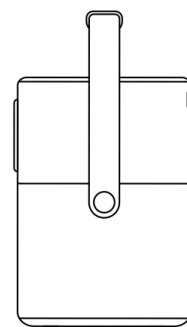

Tips: Actual projection size and distance may deviate slightly from laboratory data.

8.2 Auto Focus

Auto focus will be activated after each shift.

You can also turn off the auto focus function through [Settings]-[Projection Settings]-[Auto Focus].

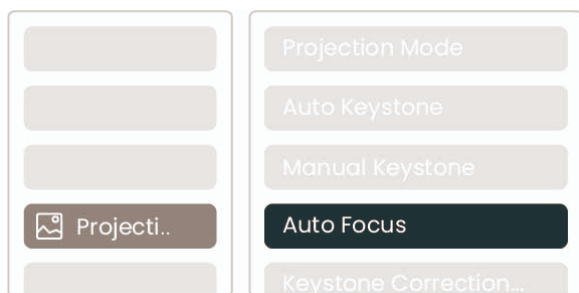

⚠Attention: If you have already determined the location of the projector, it is recommended that you turn off autofocus in the settings to get a better viewing experience.

8.3 Auto Keystone Correction

As you move the machine, the T2 automatically performs trapezoidal correction, depending on the target wall.

⚠Attention: The angle of the auto keystone cannot exceed 15 degrees up, down, left, and right.

8.4 Auto Screen Alignment and Auto Obstacle Avoidance

⚠ Note: When using the Auto Screen Alignment and or Auto Obstacle Avoidance functions, make sure the Auto Keystone and Auto Focus functions are turned on.

1. Obstacle avoidance may not work when there are white or other light-colored objects in the target screen.



2. The backdrop should have a distinct black or other colored border, except for anti-light screens which do not require a border.



3. Before using the auto screen alignment function:

Please ensure the projection screen is larger than the screen area, and do not block the area within the central square frame of the screen.

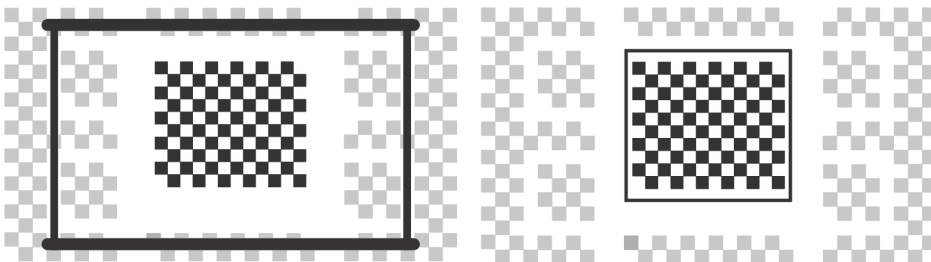

8.5 Electric Focus

You can also adjust the focus by clicking on the buttons on the remote control to get your desired picture.



Auto Focus

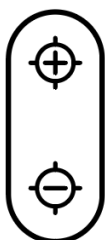

Manual Focus

8.6 Manual Keystone Correction

If you need to adjust the screen further, you can adjust the screen by dragging the arrows by selecting "Manual Keystone" in the settings.

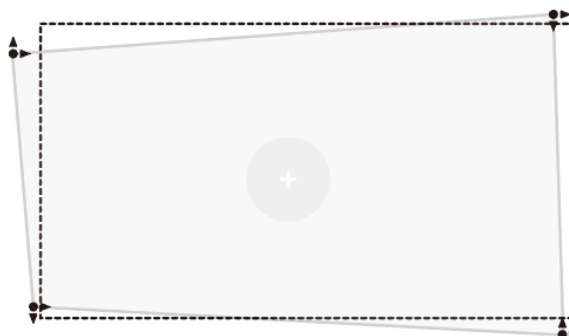
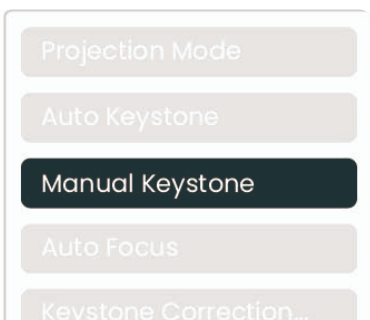

8.7 Projection Zoom

After auto-focusing, the zoom effect will be reset. If you want to save the zoom, please try to turn off the auto focus when the picture is clear.

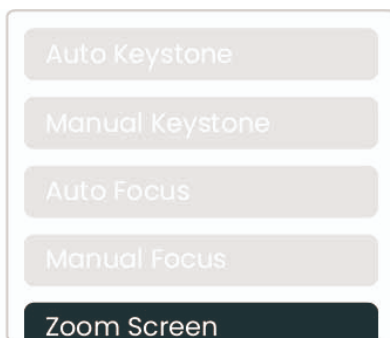

9. Picture Settings

You can select [Image Settings] or [Projection Settings] in [Settings] to adjust the projector image.

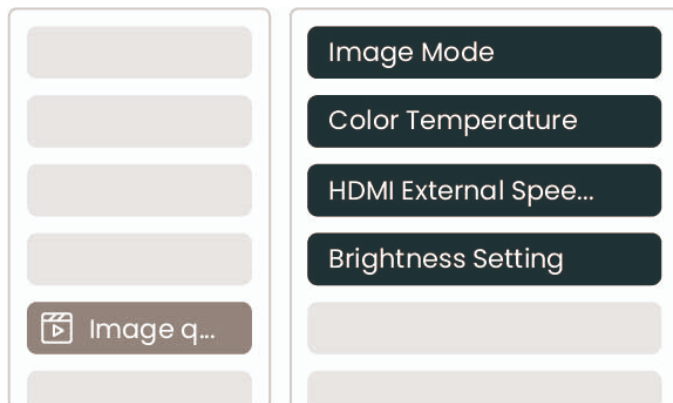

9.1 Brightness Settings

You can also adjust the brightness by adjusting the settings; However, battery life time will change as well.



9.2 Image Color Settings

Ajust the image color through [Home] - [Settings] - [Image Quality] -[Picture Mode].

You can set the [**Brightness**], [**Contract**], [**Sharpness**], [**Color**] of the screen in this [User Mode].

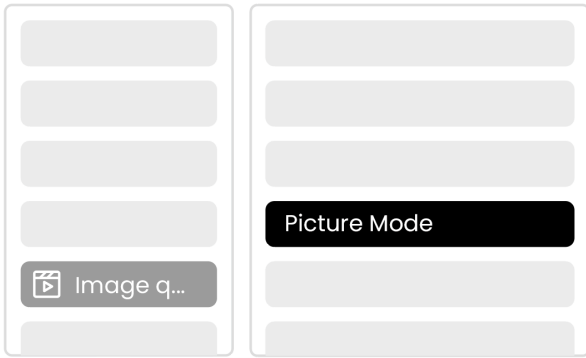

⚠ Attention: The Image color setting will only take effect when playing pictures or videos.

10. Connectivity

10.1 HDMI, USB, Lan Port

The T2 has an HDMI 1.4 port and a USB 2.0 port. Before using these ports, make sure your external devices are compatible with this format.

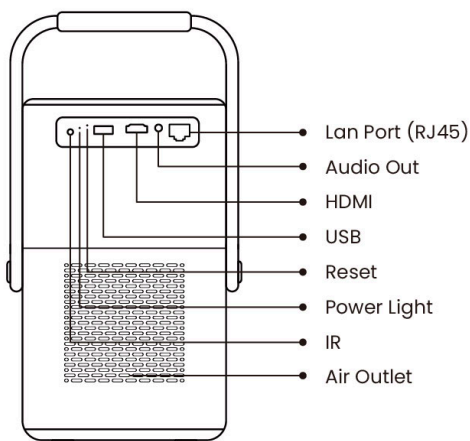

10.1.1 USB

⚠ Notice: T2 currently only supports reading FAT32 and NTFS USB flash drives, and currently does not support reading exFAT formatted USB flash drives.

10.1.2 HDMI

If you're meet some troubles while using HDMI, please try these solutions below:

Method 1. Switch HDMI EDID version to 1.4 in your external device settings.

Method 2. Try changing the HDMI cable.

Method 3. Try to replace other external devices with HDMI function and check whether the HDMI interface of external device is working.

1

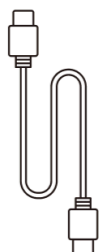

2

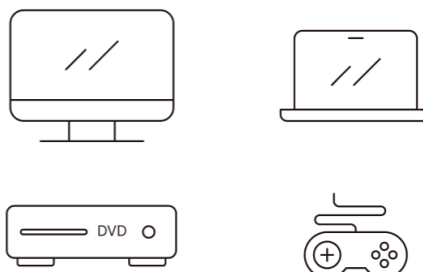

10.1.3 Lan

The Lan interface of T2 is an RJ45 interface. If you encounter lag when using the same screen with your phone, you can try to use this interface to connect to the network and use the same screen.

10.2 Wireless Connections

Wi-Fi Screen Mirroring

⚠ Notice: If you need to mirror Netflix, Prime Video, etc. to the projector, please connect a TV Dongle/Stick or other products with these streaming media via HDMI.

10.3 Yaber App

You can download the Yaber App from the Google Play Store or Apple App store for better screen casting!

⚠ Notice: Scan the QR code below to download the Yaber App.



10.3.1 Screen Share

Tip: To enhance your experience during screen sharing, download the [Yaber] app from the Apple App Store or Google Play Store.

- 1 Ensure your phone and the projector are connected to the same Wi-Fi network.
- 2 In the Yaber app, tap [Connect Device] and select the device named [Yaber_T2_xxxx] to connect.
- 3 Once connected, select the screen mirroring option in the Yaber app to share your phone screen with the projector.
- 4 To end the screen share, go to your phone's control center, select the device, and stop sharing.

⚠ Attention: If you need to share the screen from streaming apps like Netflix, Disney, or Prime Video, enter the Dongle system to share.

🔔 Tip: If you prefer not to use the Yaber APP, please follow these steps: (Only the step 2 is different)

- 1 Ensure your phone and the projector are connected to the same Wi-Fi network.
- 2 In the screen mirroring settings on your smartphone, select the device named [Yaber_T2_xxxx] to connect.
- 3 To end the screen share, go to your phone's control center, select the device, and stop sharing.

10.4 Phone Control

⚠ Attention: Yaber App cannot control TV Dongle.

⚠Attention: The phone and projector need to be connected in the same Wi-Fi environment.

The [remote control] function of Yaber App can help you control the projector without a physical remote control.

10.5 NFC Settings

Tip: If you need to use NFC for screen mirroring, download the [Yaber] app from the Apple App Store or Google Play Store to synchronize your screen.

1 When using NFC, ensure your phone and the projector are connected to the same Wi-Fi network.

2 Use an NFC-enabled phone and lightly tap the NFC area on top of the device to use this feature.

⚠Attention: Ensure NFC is turned on in your phone's settings.

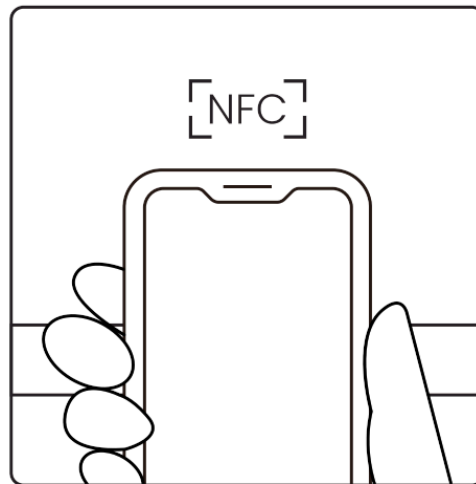
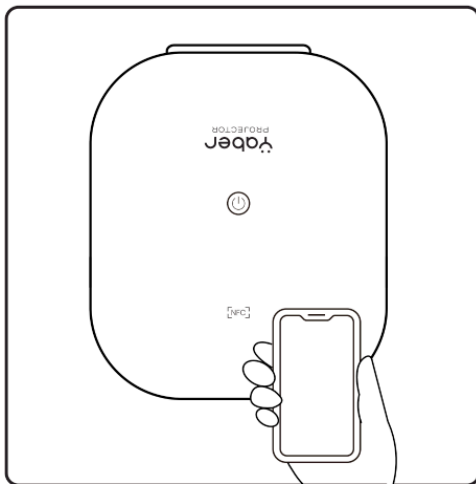

11. T2 Dongle

11.1 Dongle Overview

TV Dongle

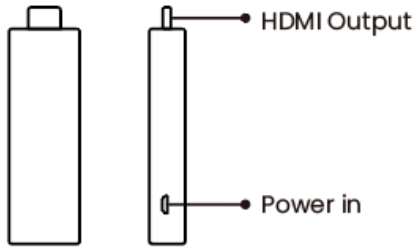

Adapter (Power in + Video Source)

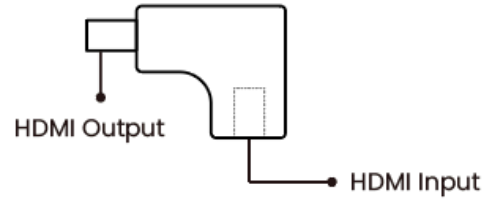

Remote Control

⚠ Attention: When using Google TV for the first time, follow the screen prompts for remote control pairing and other settings.

To pair, hold down the pairing button (←) and (🏠).

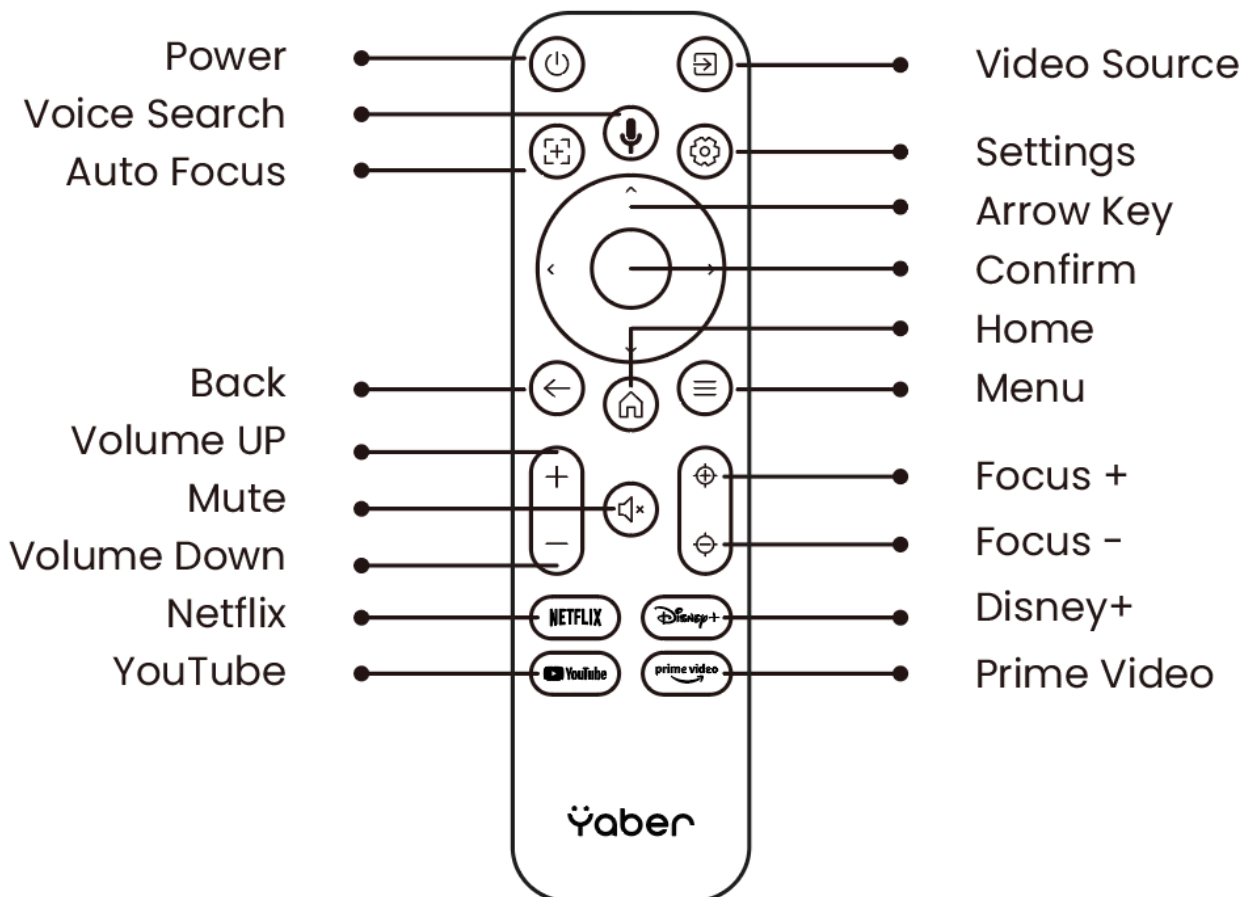

Dongle Installation

⚠ Notice: When using Dongle on the T2/T2 Plus, it must be connected via the Yaber Adapter. The Yaber adapter combines power and video source function.

Step1: Connect the dongle with the adapter

Step2: Connect the adapter with the HDMI port of the projector

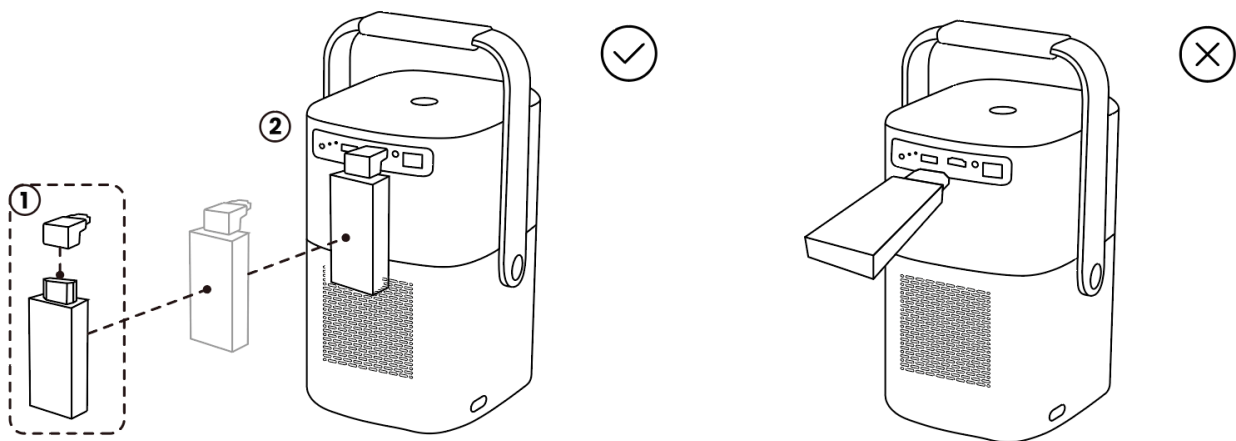

How to Use TV Dongle

After connect TV Dongle to the HDMI Port on T2, Click [HDMI] on the Homepage to Entry TV

⚠ Notice: When you turn on the device, it will take about 30s to wait before the Dongle screen appears.



12. Bluetooth Settings

You can connect your phone to the projector via Bluetooth and enter Bluetooth speaker mode anytime after confirmation. Please pair the device named [Yaber_T2series_xxxx].

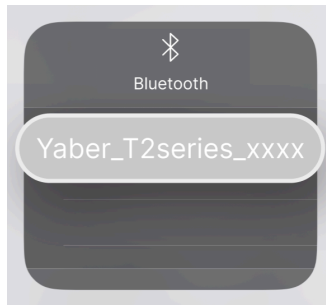

In Bluetooth Speaker mode, you can also turn off the screen and use the T2 as an outdoor



stereo.

13. System Upgrade

Tips: You can check the system status of your device in [Settings]-[About]-[Upgrade]

If you need to upgrade the software, please go to [Settings]-[About]-[System information] and select the corresponding [MAC address] and send it to the support team at service@yaber.com.

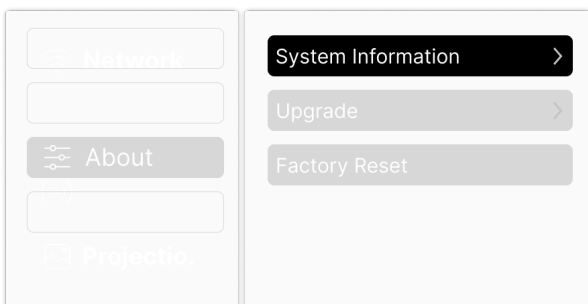

14. Quiet Mode

Notice: After turning on Quiet Mode, the noise of the machine will slowly decrease within 5 minutes.



You can turn on Quiet Mode from the main page, which will provide you with a quieter and more subdued picture by reducing brightness and fan speed.