

# DALI OBERON

1 C - 7 C - ON-WALL C

MANUAL



IN ADMIRATION OF MUSIC



# Contents

|  |    |
|--|----|
| Introduction   | 2  |
| 1. OBERON C Overview                                     | 3  |
| 2. Unpacking   | 4  |
| 3. Positioning and Installation                          | 6  |
| 3.1 OBERON 1 C & OBERON 7 C – Positioning                | 8  |
| 3.2 OBERON 7 C – Floor spikes or feet                    | 9  |
| 3.3 OBERON ON-WALL C – Positioning                       | 10 |
| 3.4 Using OBERON 1 C and ON-WALL C wall hanging features | 11 |
| 4. Speaker Connecting and Configuring                    | 13 |
| 5. Listening and Using                                   | 16 |
| 6. Fault Indication                                      | 18 |
| 7. Technical Specifications                              | 19 |

# Introduction

Thank you for choosing DALI OBERON C speakers. DALI is renowned for continually striving to enhance the experience of music, while simultaneously designing audio products that better suit our lives and homes. The OBERON C series of active wireless speakers is an exhilarating expression of those twin aspirations.

OBERON C speakers are technologically advanced electro-acoustic products that require thoughtful installation to reach their full potential. We recommend that you read this manual carefully, and follow its advice, when installing your OBERON C speakers. Please also read the Important Safety Instructions contained within the document pack.

Following this introduction the manual covers unpacking, positioning and installation, setup, and use, but begins with a short overview of the OBERON C range.



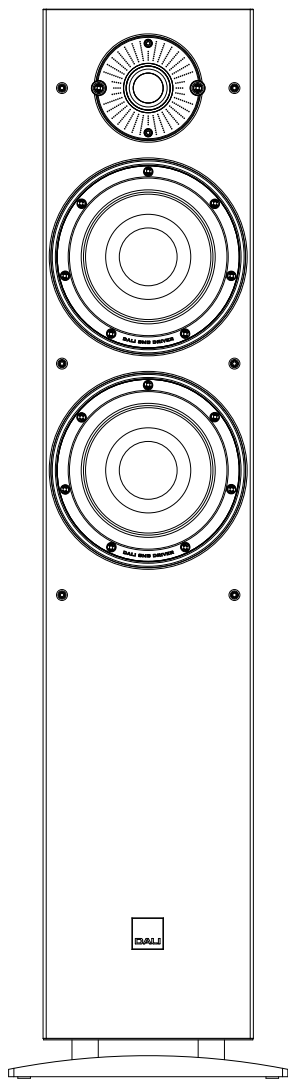

OBERON 7 C

## 1. OBERON C Overview

The OBERON C series comprises three active, wireless speaker models designed primarily for use in stereo audio systems: the OBERON 1 C, the OBERON 7 C and the OBERON ON-WALL C.

The OBERON 1 C is a compact speaker intended for wall or stand-mounting. The OBERON 7 C is a floor-standing speaker. And the OBERON ON-WALL C is a low profile speaker designed specifically for wall-mounting.

The OBERON C series is designed specifically for use with either the DALI SOUND HUB or DALI SOUND HUB COMPACT wireless streaming preamplifiers. The SOUND HUB and SOUND HUB COMPACT enable a variety of traditional hardware and streaming-based audio sources to be broadcast to each connected OBERON C speaker.

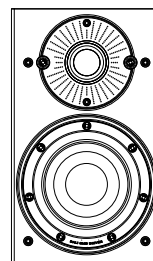

OBERON 1 C

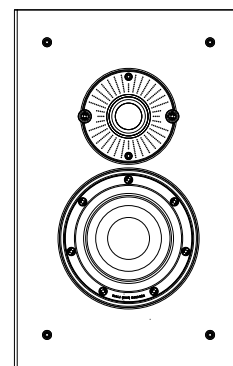

OBERON ON-WALL C

### NOTE:

**OBERON C speakers are equipped to be used in home theatre surround and front channel roles. However, the DALI SOUND HUB and SOUND HUB COMPACT are currently only able to broadcast conventional stereo. The DALI SOUND HUB is engineered to support multi-channel broadcast functionality should this become available.**

### NOTE:

**OBERON C speakers can be used with either DALI SOUND HUB or SOUND HUB COMPACT.**

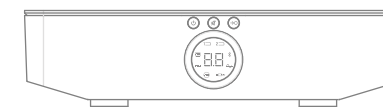

SOUND HUB



SOUND HUB COMPACT

## 2. Unpacking







The contents of each DALI OBERON C pack is illustrated in Diagram 1.

Take care when unpacking your DALI OBERON C speakers. Be especially careful not to touch the bass driver cones or tweeter domes.

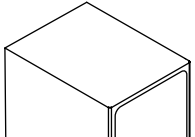
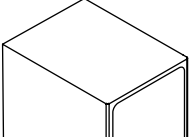
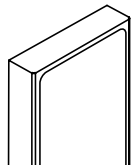
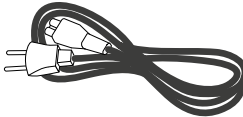
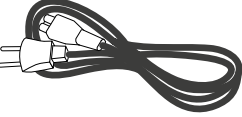
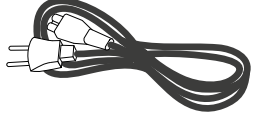
**NOTE:**

We suggest that you retain the OBERON C packaging for future use. However, if that is not possible, please dispose of it responsibly.

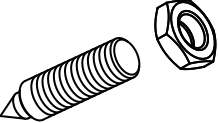
DIAGRAM 1

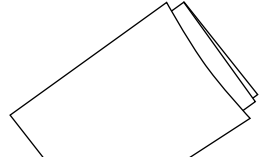
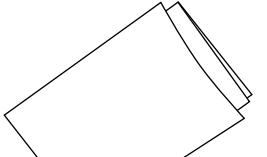
| 1 C   |    | 7 C   |    | ON-WALL C   |    |
|---|----|---|----|---|----|
|   | x2 |    | x1 |    | x1 |
|   | x2 |    | x1 |    | x1 |
|  | x8 |    | x4 |    | x4 |
|   | x8 |    | x4 |    | x2 |
|  | x4 |  | x1 |  | x1 |

## 2. Unpacking

DALI OBERON C speakers are supplied with grilles fitted. However, tweeter protection masks beneath the grilles must be removed before the speakers are used. To remove a mask, detach the speaker grille by pulling it gently away from the cabinet, lift the mask away, and replace the grille. This is illustrated in Diagram 2.

DIAGRAM 2

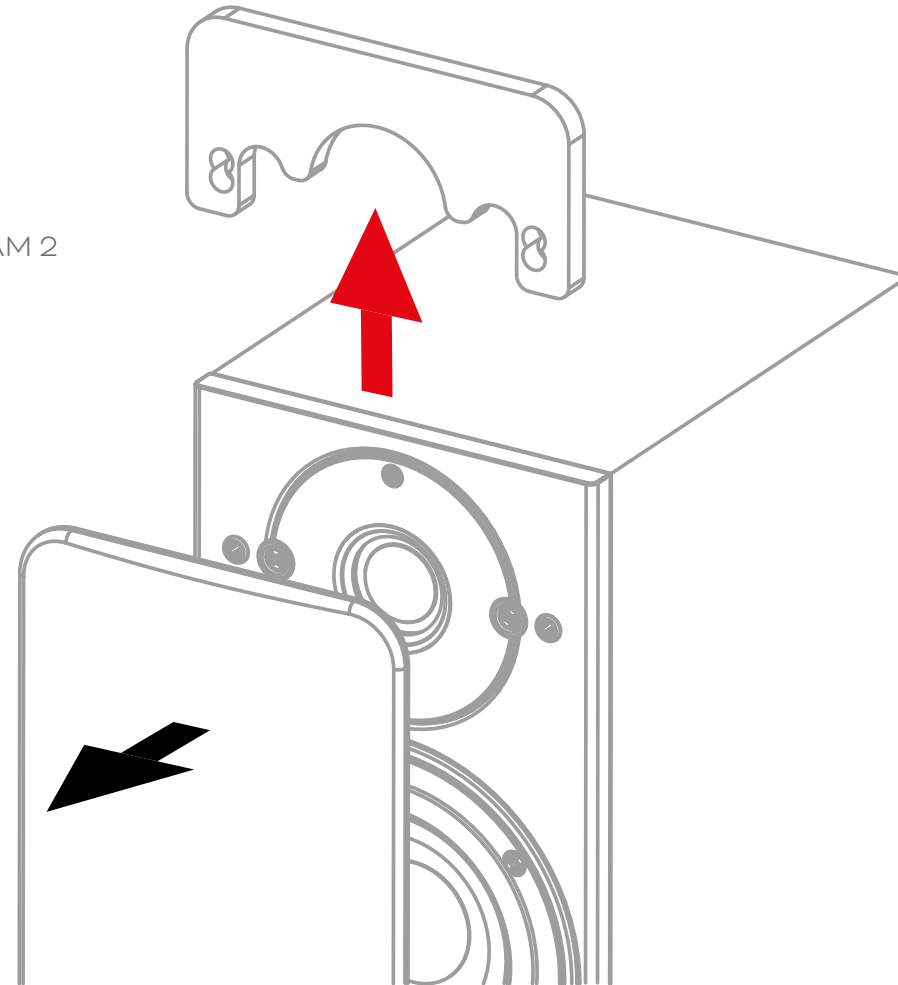





### 3. Positioning and Installation

Although OBERON C speakers need no wired signal connection, they require connection to a mains power supply. Use the cables supplied to connect the speaker rear panel mains sockets to mains power. The location of the mains sockets is illustrated in the rear panel Diagram 4.

DIAGRAM 4

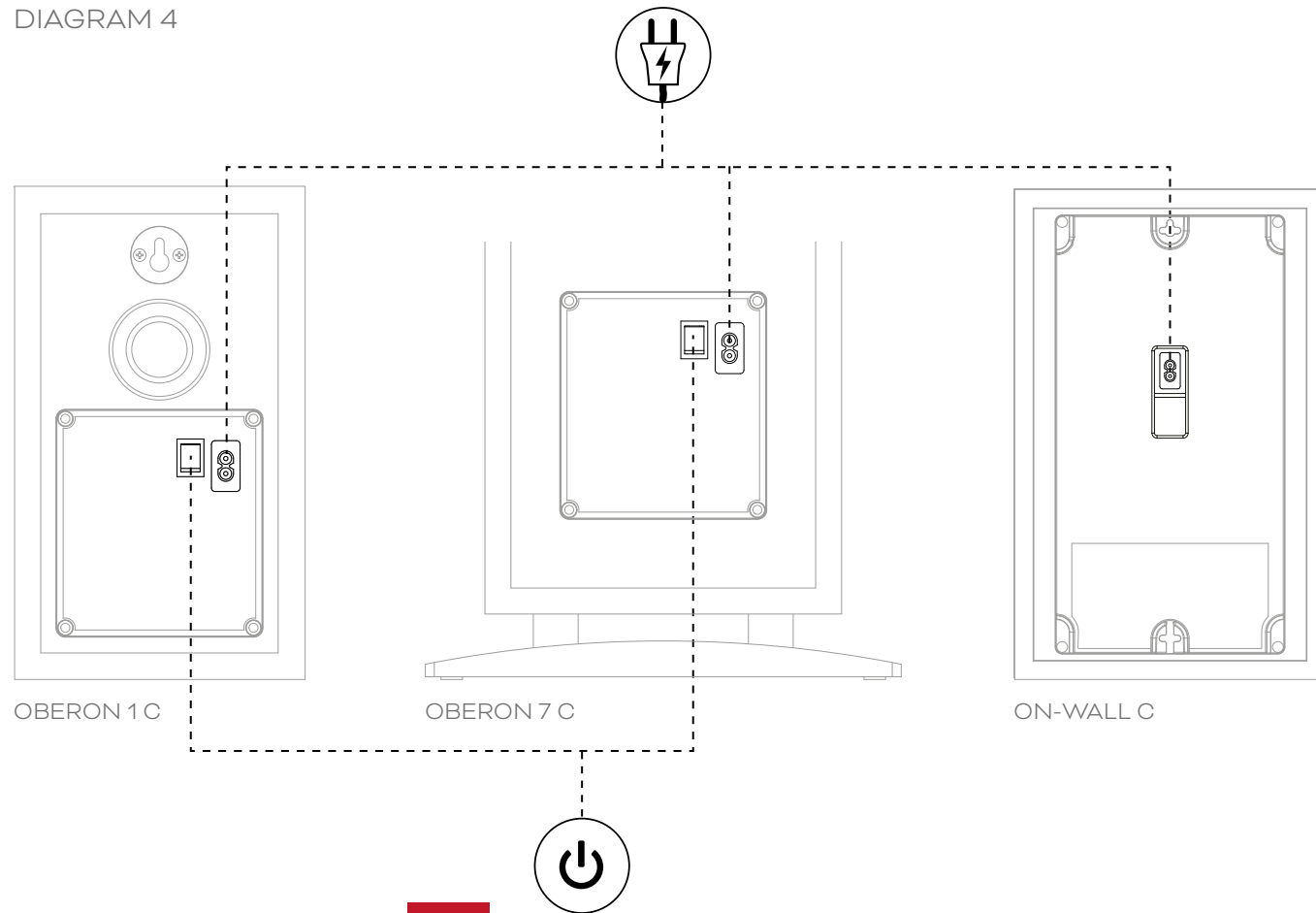

IN ADMIRATION OF MUSIC



### 3.1 OBERON 1 C & OBERON 7 C - Positioning

OBERON 1 C speakers can be mounted on either speaker stands, shelves, wall brackets or furniture units. The speakers also incorporate keyhole slots on their rear panels that enable them to be hung directly on walls. Mounting your OBERON 1 C speakers on stands is likely to result in the best audio performance. However, great results can also be obtained with wall, shelf and furniture mounting.

OBERON 7 C speakers are intended to be placed directly on the floor and are not suitable for any other kind of installation.

Pairs of OBERON 1 C and OBERON 7 C speakers should generally be positioned between 2.0 m and 4.0 m apart with the primary listening area a similar distance away. OBERON 1 C speakers should ideally be located at, or slightly below, listening head height. Always aim to keep the speakers away from room corners and try to ensure

that the acoustic environment around each speaker is similar. Solid walls and heavy curtains, for example, would constitute different acoustic environments.

It is likely to be beneficial to position the speakers initially at least 0.3 m away from the rear wall. Changing the distance to the rear wall can be used to adjust the prominence of bass frequencies. For less bass, move the speakers further from the wall.

OBERON C speakers feature response characteristics optimised for installation without an inward angle towards the listening area. They are best aligned at right angles to the rear wall.

OBERON 1 C and OBERON 7 C positioning is illustrated in [Diagram 3](#).

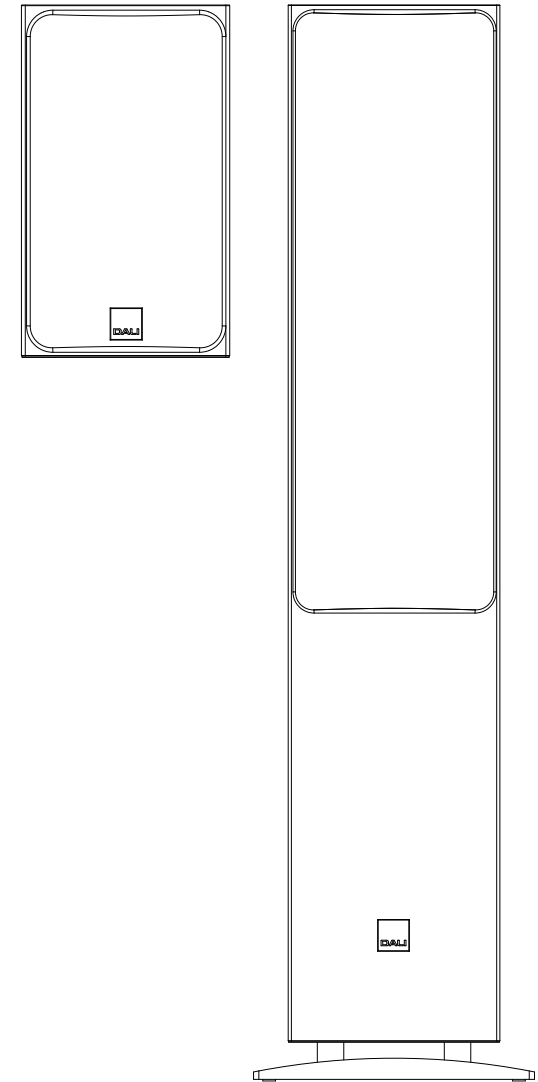



### 3.2 OBERON 7 C - Floor spikes or feet

The plinths fitted to the underside of OBERON 7 C speakers incorporate screw holes for the installation of the supplied floor spikes. We recommend that floor spikes are employed if the speakers are to be used on carpeted floors. If the speakers are to be installed on non-carpeted floors, the supplied self-adhesive rubber pads can be used in place of the floor spikes. To fit the floor spikes, screw them into the plinth holes and tighten them with the locknuts using a 10 mm spanner. Once the speakers are located in their final position, the floor spikes can be adjusted so that the speakers are vertical and firmly stable.

#### NOTE:

**Floor spikes can be used on non-carpeted floors with coins placed between the floor and the floor spike tips.**



Always take care when fitting floor spikes or when moving speakers with floor spikes fitted.

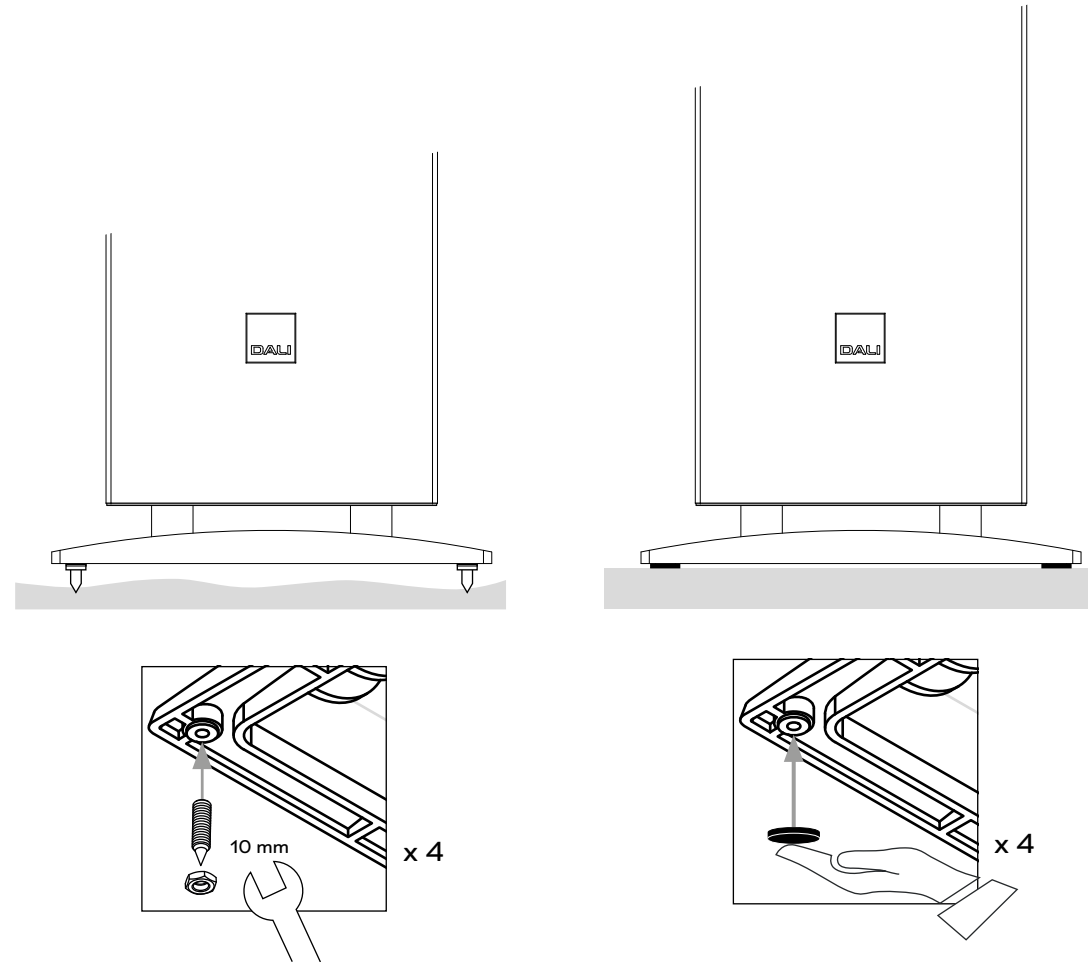

### 3.3 OBERON ON-WALL C - Positioning

OBERON ON-WALL C speakers are designed specifically to be wall-mounted in home environments where their low profile dimensions aid compatibility with interior design schemes. The speakers incorporate keyhole slots in their rear panels that enable them to be wall-hung using a single screw. Both portrait and landscape (using two mounting screws) orientation is possible. However, portrait orientation is likely to result in better performance.

OBERON ON-WALL C speakers should generally be positioned between 2.0 m and 4.0 m apart with the primary listening area a similar distance away. If the speakers are to be used for TV audio, they should be located equidistant either side of the TV on its horizontal centre line. Speakers used for TV audio are generally better located closer together than for music use alone. Aim for each speaker to be no more than 0.5 m distant from the side of the TV.

For more general applications OBERON ON-WALL C speakers should ideally be located at, or slightly below, listening head height. Aim to keep the speakers away from room corners and try to ensure that the acoustic environment around each speaker is similar. Solid walls and heavy curtains, for example, would constitute different acoustic environments.

OBERON ON-WALL C positioning is illustrated in [Diagram 3](#).

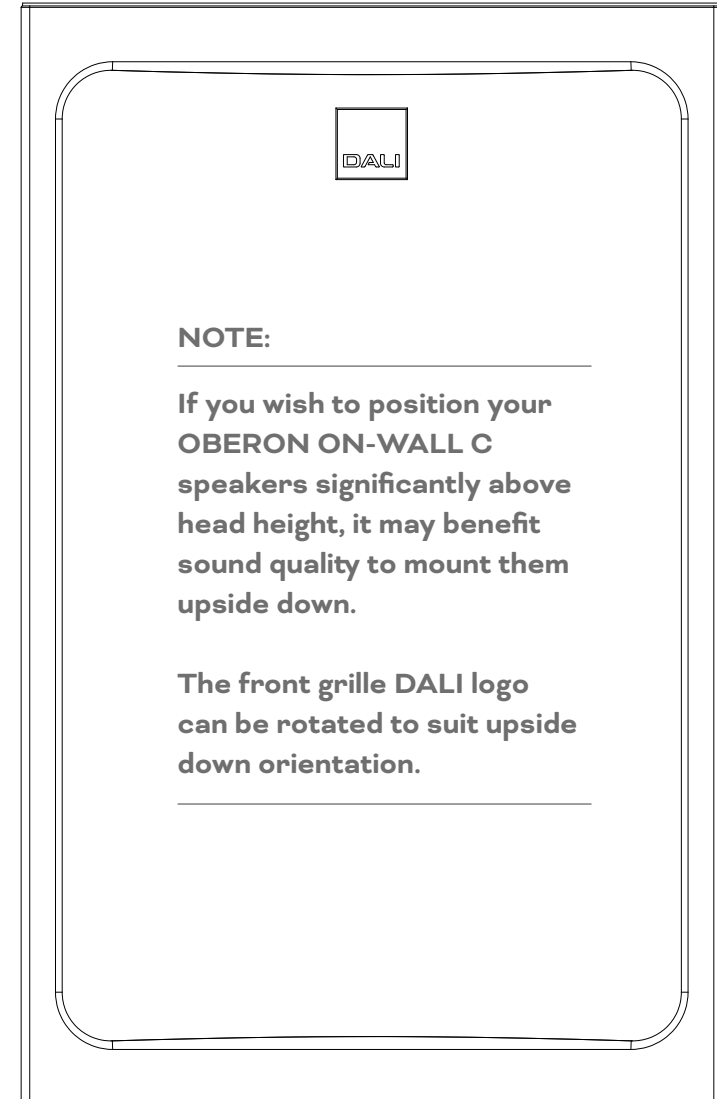

### 3.4 Using OBERON 1 C and ON-WALL C wall hanging features

The OBERON 1 C and ON-WALL C incorporate keyhole slots on their rear panels that enable them to be directly wall-mounted. Before you begin you must be confident that the wall and wall fittings you intend to use are easily able to support the weight of the speaker. If you are unsure of the suitability of the wall, or of your ability to securely insert a screw, you should seek advice.

OBERON 1 C and ON-WALL C wall hanging is illustrated in Diagram 5.

**OBERON 1 C:** Use wall-mounting screws of 3–5 mm (0.12–0.20 inches) shank diameter and 10 mm (0.4 inches) maximum head diameter. Leave 15 mm (0.6 inches) screw length protruding from the wall surface.

**OBERON ON-WALL C:** Use wall-mounting screws of 3–5 mm (0.12–0.20 inches) in shank diameter and 9 mm (0.35 inches) maximum head diameter. Leave 7 mm (0.28 inches) screw length protruding from the wall surface.

DIAGRAM 5

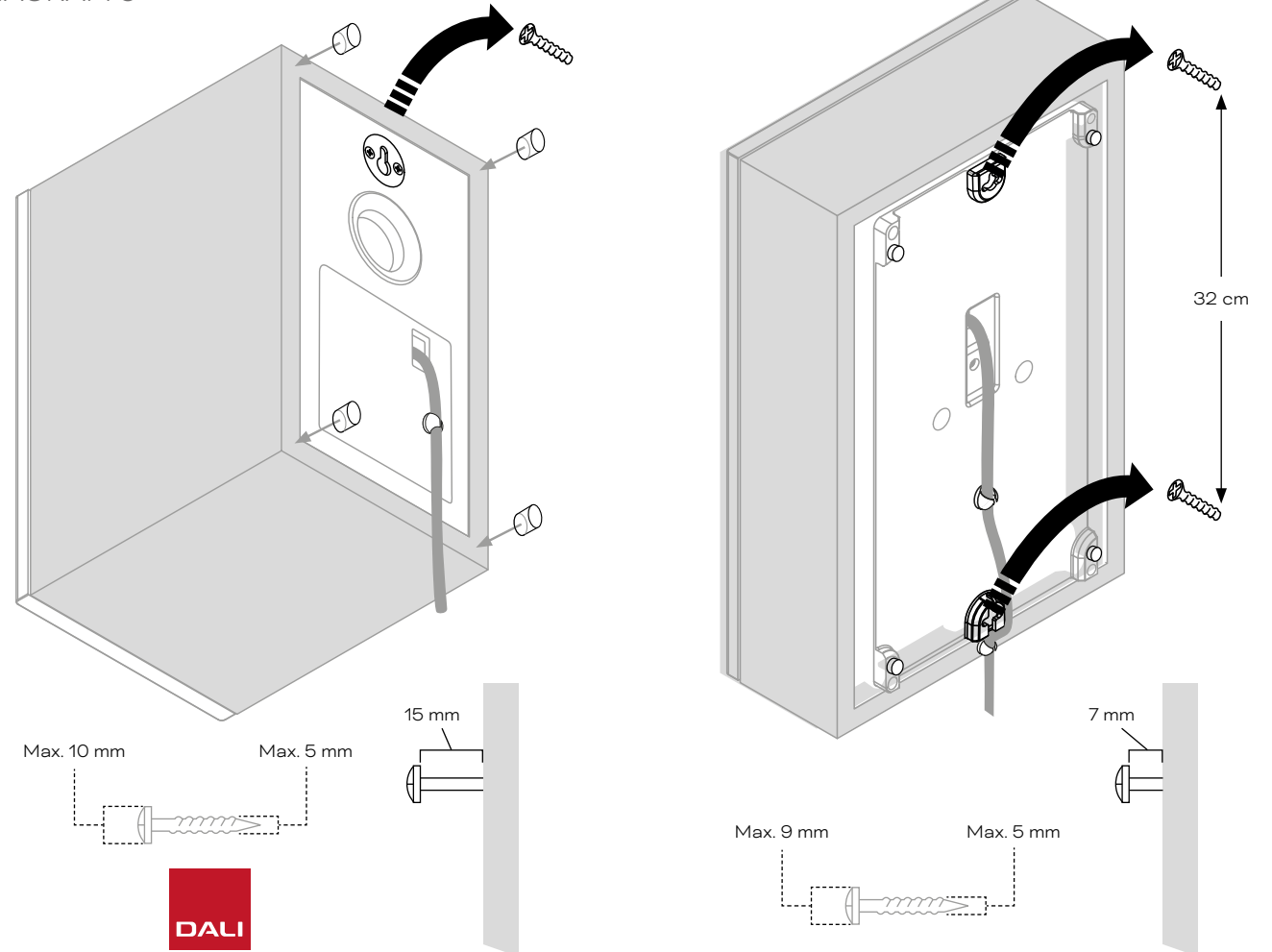

### 3.4 Using OBERON 1 C and ON-WALL C wall hanging features

#### OBERON 1 C

- Once the preferred speaker positions have been established, insert a mounting screw in the wall on the centre line of the speaker position, 30 mm (1.25 inches) below the speaker top panel.
- Attach the supplied adhesive rubber feet to the rear corners of the speakers. Using the rubber feet reduces the possibility of the speakers vibrating against the wall.
- The speakers can now be lifted onto the screws so that the screw heads engage with the keyhole slots.

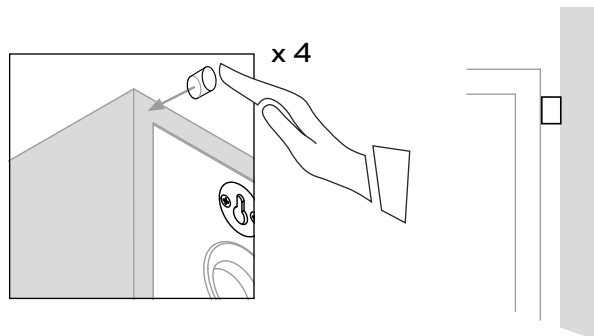

#### OBERON ON-WALL C

- For portrait speaker orientation, once the preferred speaker positions have been established, insert a mounting screw in the wall on the centre line of the speaker position 30 mm (1.25 inches) below the speaker top panel.
- For landscape speaker orientation, once the preferred speaker positions have been established, insert two mounting screws in the wall 321 mm (12.6 inches) apart on the speaker position horizontal centre line.
- Attach the supplied adhesive rubber feet to the rear spacing pads of each speaker. Using the rubber feet reduces the possibility of the speakers vibrating against the wall.
- The speakers can now be lifted onto the screws so that the screw heads engage with the keyhole slots.

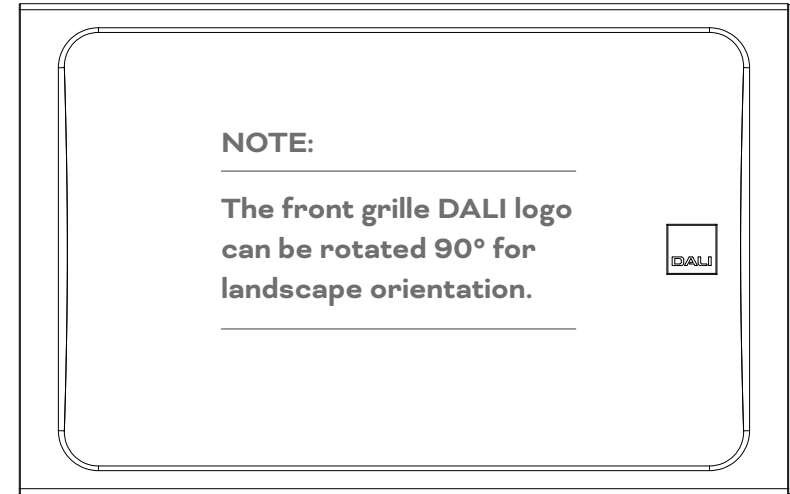

## 4. Speaker Connecting and Configuring

The OBERON C series is designed to be used with either the DALI SOUND HUB or SOUND HUB COMPACT wireless streaming preamplifiers.

### NOTE:

If you are installing either a DALI SOUND HUB or SOUND HUB COMPACT at the same time as you are installing OBERON C speakers, we recommend that you have its user manual to hand.

Once all the OBERON C speakers are installed in position and connected to mains power, switch them on using their rear panel mains power switch. The mains power switch locations are illustrated in [Diagram 4](#). When switched on, the power indicators on the rear panels will illuminate red. With all the speakers switched on, follow the steps described on the next page.

### NOTE:

You may need to temporarily unmount OBERON ON-WALL C speakers from the wall to gain access to their rear panels.

### NOTE:

If your OBERON C speakers have been previously used they may need to be reset. To reset your speakers use an appropriate tool to press and hold the rear panel RESET pinhole buttons for 1 second. The location of the reset button is illustrated below.

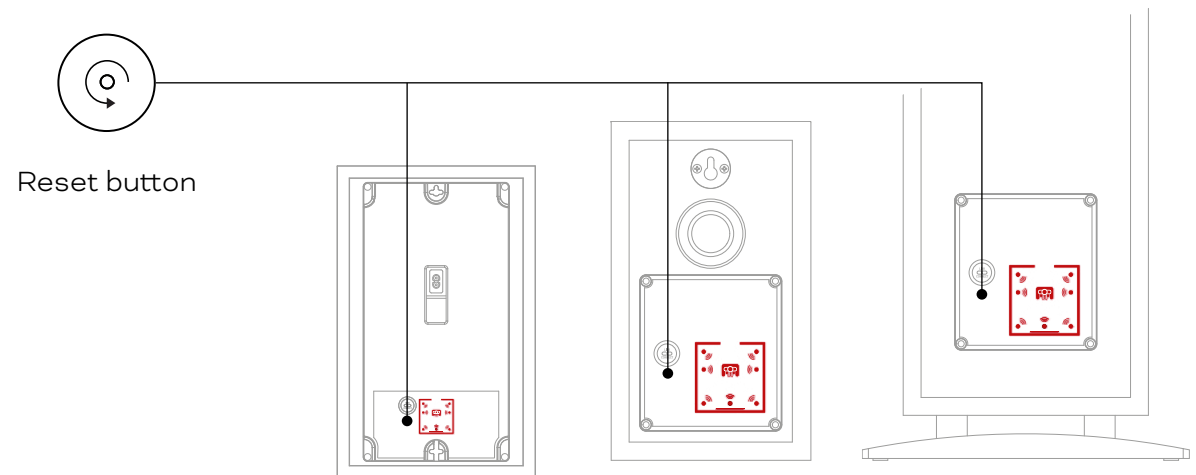

IN ADMIRATION OF MUSIC

## 4. Speaker Connecting and Configuring

Press the LINK & CONNECT button on the SOUND HUB or SOUND HUB COMPACT **A**. It will indicate speaker connection mode as described in its user manual.

- Now return to one of the OBERON C speakers in your system and press its rear panel LINK & CONNECT button **B**. The power indicator will illuminate green and the speaker channel matrix indicators will illuminate cyclically while connection to the SOUND HUB or SOUND HUB COMPACT is underway.
- When connection is established, the cyclic illumination will stop, leaving just the left and right channel matrix indicators flashing slowly. The speaker will play a short confirmation tone.
- With the speaker connected to the SOUND HUB or SOUND HUB COMPACT, it can be assigned to either the left or right channel. The channel matrix display on the speaker rear panel incorporates indicators at each channel position.

Pressing the speaker LINK & CONNECT button changes the channel specified for the speaker **C**. If the first speaker is to be assigned to the left channel, the LINK & CONNECT button will only need to be pressed once because the left channel is the default. If the first speaker is to be assigned to the right channel, press the LINK & CONNECT button twice to select the right channel.

- With the first speaker connected to the SOUND HUB or SOUND HUB COMPACT and its channel assigned, move to the second speaker and repeat the process **D E**.
- When both speakers in the system are connected and their channels assigned, return to the SOUND HUB or SOUND HUB COMPACT and press its LINK & CONNECT button to complete the speaker connection process **F**. Both speakers will play a short confirmation tone and the SOUND HUB or SOUND HUB COMPACT will exit speaker connection mode.

The SOUND HUB or SOUND HUB COMPACT connection procedure is illustrated in [Diagram 6](#).

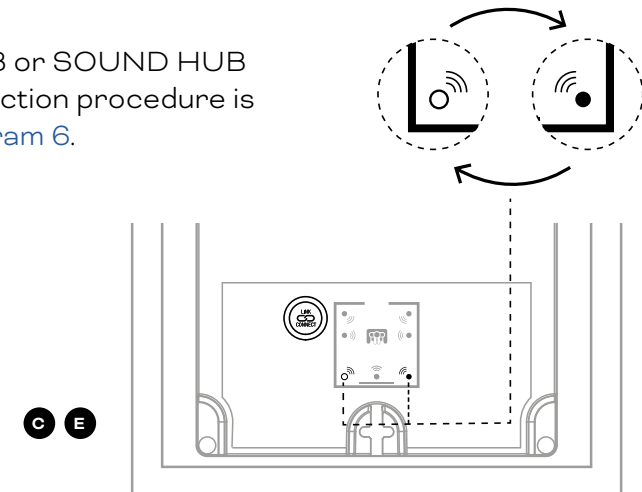

## 4. Speaker Connecting and Configuring

DIAGRAM 6

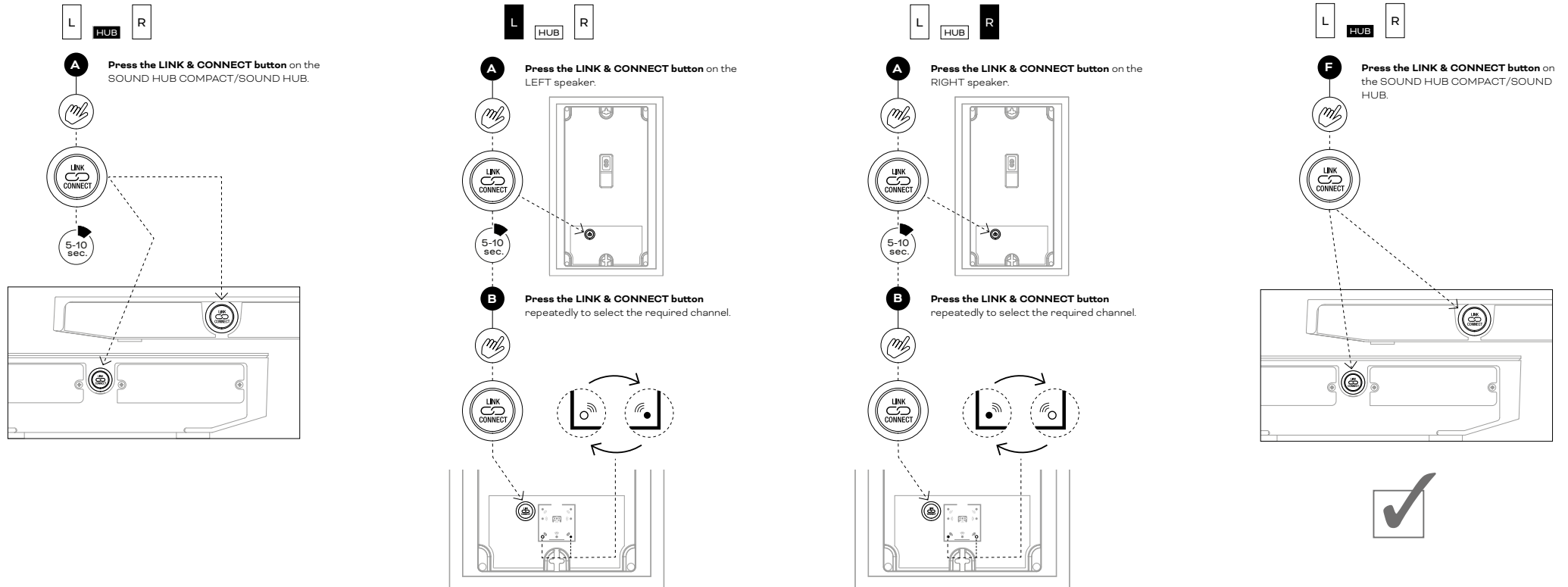



## 5. Listening and Using

Once your OBERON C speakers are installed and connected to your SOUND HUB or SOUND HUB COMPACT, you can begin listening. Select an active input source on the SOUND HUB or SOUND HUB COMPACT and slowly increase the volume. Check that both speakers in the system are working and that the stereo image at the listening position is well focussed. It's best to use some music that you know well.

Once you have become familiar with your OBERON C speakers' performance in your listening space you may wish to adjust their position to fine-tune their sound. Move the speakers closer to or further from the walls of the listening space to increase or reduce the prominence of bass frequencies. If you find the sound initially a little bright, more soft furnishings or curtains in the listening space will help. However, you will likely find that any brightness will diminish as you become more familiar with the sound of your new speakers.

OBERON C speakers can be used without their grilles fitted. However, we strongly recommend that grilles are used if your home includes inquisitive children or pets. Detach the grilles by pulling them gently away from the body of the speaker. Replace the grilles by aligning the grille pegs and sockets and pushing them gently together.

We hope and expect that you will enjoy your OBERON C speakers from the first moment. However, there may be subtle performance changes in the first hours or days of use as, for example, driver suspension components loosen. This is more likely if your speakers have been stored at below their subsequent ambient operating temperature.

## 5. Listening and Using

Your OBERON C speakers are capable of reproducing music at volume levels well in excess of those usually required in typical domestic listening spaces. However, we understand that it is sometimes rewarding to turn up the volume and enjoy your music loud. On those occasions, please take your neighbours into account, and listen for any distortion that might indicate that your speakers are at risk of damage.

Your OBERON C speakers don't require any special treatment beyond the kind of care that you would give other high value items in your home. Use a soft, dry cloth to dust off the cabinet panels. We do not recommend the use of any cleaning fluids or sprays, but if you wish to use furniture polish, apply it to a cloth rather than directly to the speaker panels. Dust can be removed from bass and midrange driver cones and from fabric grilles using a soft brush. We do not recommend any attempt to clean or dust tweeter domes.

DALI may occasionally release updated firmware for your OBERON C speakers which can be updated via the USB connector on the rear panel. Updated firmware may improve performance and reliability or introduce new features. Firmware updates will be made available for download from the DALI website and will be accompanied by full instructions on the update process.

## 6. Fault Indication

In the unlikely event of your OBERON C speakers failing to operate correctly, the fault indications and fixes described here may provide a solution. Further help is always available from DALI, your local retailer, or via the support pages of the DALI website.

### Wireless audio link error

All seven speaker position indicators repeatedly blink twice.

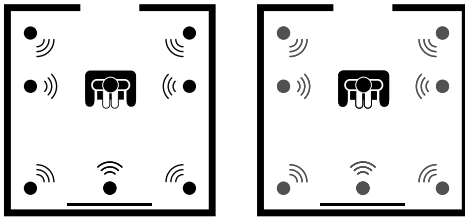

#### Fix:

First check that the SOUND HUB or SOUND HUB COMPACT is switched on. If this doesn't fix the problem, switch the failing OBERON C loudspeaker off and on. If the problem persists then reset the system (SOUND HUB/ SOUND HUB COMPACT and speakers) as described in its user manual and re-connect the speakers as described in Section 4 of this manual.

### General hardware failure

The rear panel service indicator alternates between red and amber.



#### Fix:

Switch the OBERON C off and on again. If the problem persists, contact DALI or your local retailer or distributor for service advice.

### Amplifier over-temperature

The rear panel service indicator blinks red.



#### Fix:

Pause the music and allow the amplifier to cool down. It will switch back on automatically. If the problem persists, a General hardware failure will be indicated. Contact DALI or your local retailer or distributor for service advice.

Service indicator

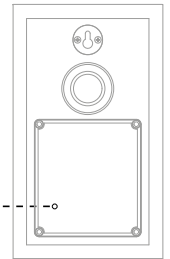

OBERON 1 C

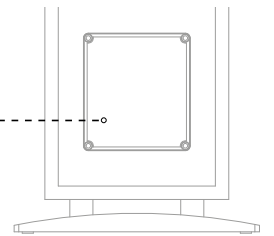

OBERON 7 C

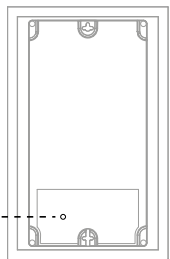

ON-WALL C



## 7. Technical Specifications

|  | OBERON 1 C  | OBERON 7 C  | OBERON ON-WALL C   |
|--|---|---|--|
| Frequency range ( $\pm 3$ dB) (Hz)         | 39 – 26,000   | 31 – 26,000   | 51 – 26,000  |
| Maximum SPL (dB)                           | 106   | 108   | 107  |
| Crossover frequency (Hz)                   | 2350  | 2450  | 2700   |
| Crossover principle                        | Full active 24 Bit DSP  | Full active 24 Bit DSP  | Full active 24 Bit DSP   |
| High Frequency driver                      | 1 x 29 mm soft dome tweeter   | 1 x 29 mm soft dome tweeter                                       | 1 x 29 mm soft dome tweeter  |
| Low frequency driver                       | 1 x 5,25"   | 2 x 7"  | 1 x 5,25"  |
| Enclosure type                             | Bass reflex (Rear ported)   | Bass reflex (Rear ported)   | Bass reflex (Rear ported)  |
| Reflex tuning frequency (Hz)               | 52  | 40  | 52   |
| Amplifier output power (W)                 | 2 x 50 W  | 2 x 50 W  | 2 x 50 W   |
| Amplifier type                             | Class-D   | Class-D   | Class-D  |
| Wireless input                             | Full 24 Bit / 96 kHz (not compressed)                                       | Full 24 Bit / 96 kHz (not compressed)                             | Full 24 Bit / 96 kHz (not compressed)  |
| Wireless Audio RF Band (MHz)               | 5150-5250 MHz and 5725-5875 MHz*  | 5150-5250 MHz and 5725-5875 MHz*                                  | 5150-5250 MHz and 5725-5875 MHz*   |
| Input Mains                                | Universal mains 100-240 VAC   | Universal mains 100-240 VAC                                       | Universal mains 100-240 VAC  |
| Maximum power consumption (W)              | 62  | 62  | 62   |
| Standby power consumption (W)              | 1   | 1   | 1  |
| Networked standby power consumption (W) ** | 1.25  | 1.25  | 1.25   |
| Time to enter networked standby            | < 20 minutes  | < 20 minutes  | < 20 minutes   |
| Recommended placement                      | Stand/ Shelf  | Floor   | Wall   |
| Recommended distance to walls (cm)         | 1 – 50  | 15 – 100  | On-wall  |
| Dimensions (H x W x D) mm                  | 274 x 162 x 234   | 1015 x 200 x 340  | 385 x 245 x 120  |
| Weight (kg/lb)                             | 4.2 kg / 9 lb   | 14.8 kg / 32 lb   | 4.9 kg / 10 lb   |
| Included accessories                       | Quick start guide, mains cable, front grille, rubber feet, silicone bumpers | Quick start guide, mains cable, front grille, rubber feet, spikes | Quick start guide, mains cable, front grille, rubber feet, silicone bumpers, cable clips |

\* Excluding Japan

\*\* Please note that the speaker will remain in networked standby if the SOUND HUB / SOUND HUB COMPACT is powered off.



IN ADMIRATION OF MUSIC

