

CITATION TOWER

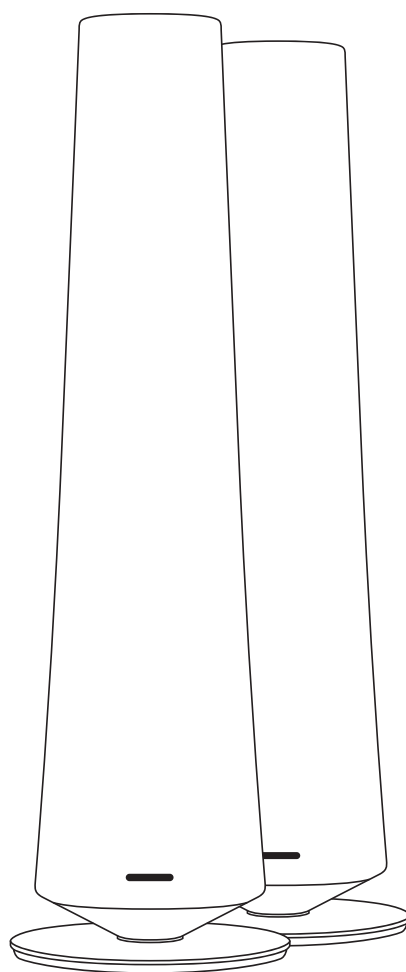

OWNER'S MANUAL

harman/kardon
by HARMAN

/ IMPORTANT SAFETY INSTRUCTIONS

Do Not Use Extension Cords

To avoid safety hazards, use only the power cord supplied with your unit. We do not recommend that extension cords be used with this product. As with all electrical devices, do not run power cords under rugs or carpets, or place heavy objects on them. Damaged power cords should be replaced immediately by an authorized service center with a cord that meets factory specifications.

Handle the AC Power Cord Gently

When disconnecting the power cord from an AC outlet, always pull the plug; never pull the cord. If you do not intend to use your speaker for any considerable length of time, disconnect the plug from the AC outlet.

Do Not Open the Cabinet

There are no user-serviceable components inside this product. Opening the cabinet may present a shock hazard, and any modification to the product will void your warranty. If water accidentally falls inside the unit, disconnect it from the AC power source immediately, and consult an authorized service center.

Safe and Stable Placement

This product may become unstable and tip over during earthquakes or if they are rocked, tipped or improperly positioned.

/ TABLE OF CONTENTS

IMPORTANT SAFETY INSTRUCTIONS.....	2
INTRODUCTION	4
WHAT'S IN THE BOX.....	5
PRODUCT OVERVIEW.....	6
PLACEMENT	9
POWER ON	11
SPEAKER SETUP	13
USING YOUR CITATION TOWER	17
SETTINGS.....	21
SPECIFICATIONS.....	23
TROUBLESHOOTING.....	24
TRADEMARKS	26

/ INTRODUCTION

This manual includes information of CITATION TOWER (primary and secondary speakers). We encourage you to take a few minutes to read this manual, which describes the products and includes step-by-step instructions to help you set up and get started. Read and understand all the safety instructions before using your product.

This product may have an important software update available. Please follow the instructions to connect the product to Wi-Fi to ensure that your product has the most recent software updates.

Design and specifications are subject to change without notice.

If you have any questions about these products, their installation or their operation, please contact your Harman Kardon retailer or customer service, or visit us at www.harmankardon.com.

/ WHAT'S IN THE BOX

Carefully unpack the box and check if the following parts are included. If any part is damaged, do not use it, contact your Harman Kardon retailer or customer service.

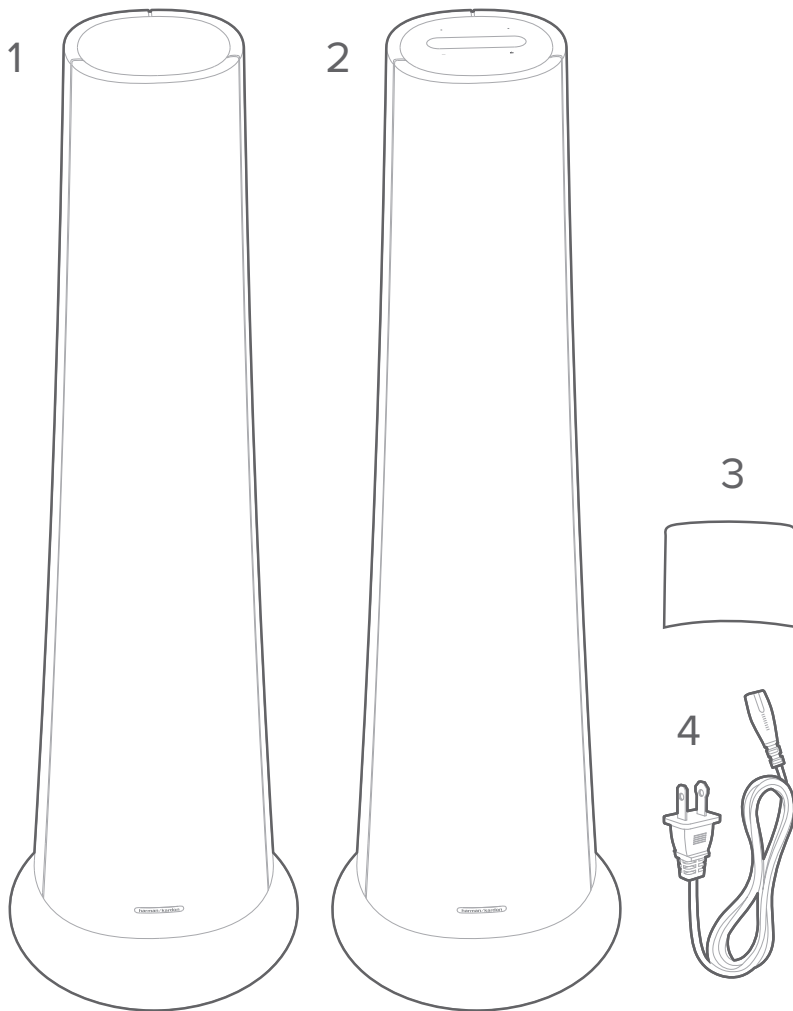

1. Main unit (Secondary speaker)
2. Main unit (Primary speaker)
3. Bottom cover x 2
4. Power cord* x 2

*Power cord quantity and plug type vary by regions.





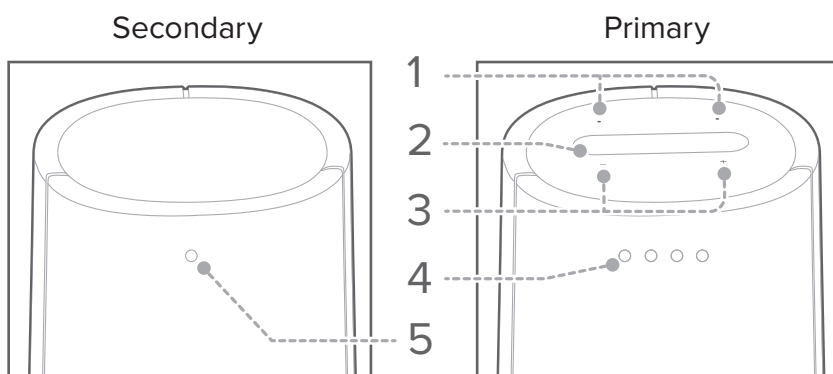

PRODUCT OVERVIEW

Back Panel and Bottom



1. Microphones





2. Touch screen

	Wi-Fi signal indicator.
	Press to mute or unmute the microphone.
	Press to activate Google Assistant.
	Press to enter Bluetooth pairing mode. Press and hold more than 3 seconds to disable Bluetooth.
	Press to customize the general settings.
	Press to set up multi-channel surround sound system with your CITATION SUB. (Optional)
	Press to check the system information of this product.



3. - / + (Volume)

- Press to decrease or increase the volume.

4. LED indicators (Google)

	White (Breathing slowly)	Listening
	White (Breathing fast)	Responding
	Amber (Constant)	Microphone muted
	White (Breathing for three times)	Power on / system startup

5. LED indicator (WiSA)

	White (Flashing)	Pairing
	White (Flashing)	Out of range / Lost wireless connection
	White (Constant for 10 seconds and then light off)	Wirelessly connected with CITATION BAR / ADAPT

Bottom Side

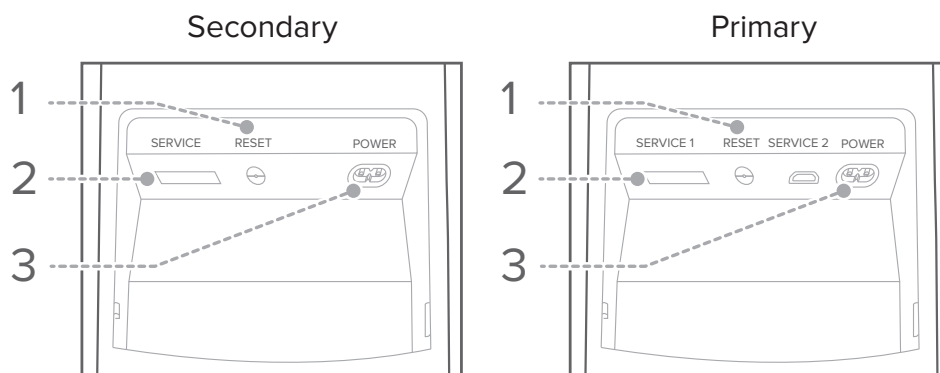

1. RESET

- Press and hold for 5 seconds to restore the factory settings.

2. SERVICE

- For service personnel only.

3. POWER

- Connect to the power supply.

/ PLACEMENT

Place your CITATION TOWER on any flat and stable surface near an AC (mains) outlet.

- 1) To achieve the best and most accurate stereo soundstage, place the speakers 6-10 feet (1.8-3 m) apart, keep an angle of 40-60 degrees between your listening position and both speakers.
- 2) Bass output will increase as the speaker is moved closer to a wall or a corner. For best sound quality, keep a minimum distance of 20 in (51 cm) between the speakers and the side and rear walls.

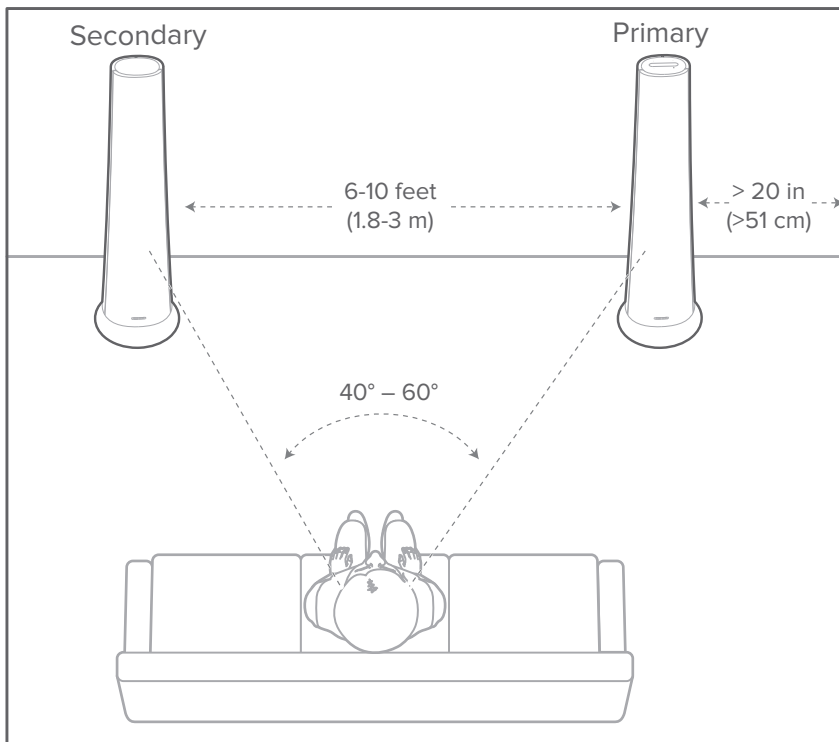

* To avoid any interference, keep a minimum distance of 5 meters (16.4 feet) between the speakers and your Wi-Fi router.

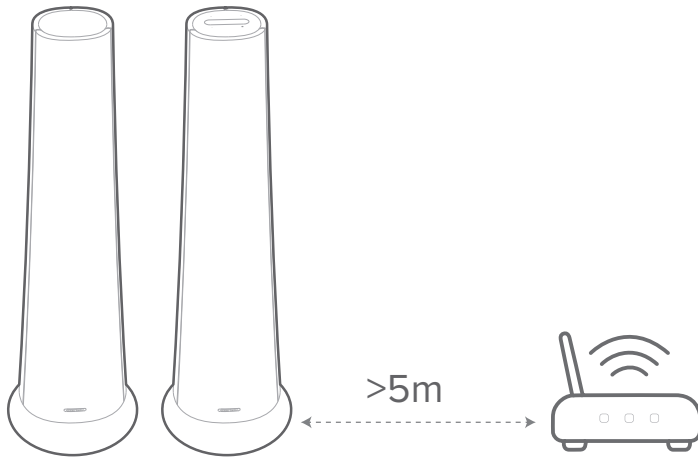

/ POWER ON

NOTES:

- Use the provided power cord only.
- When you disconnect the power cord, always pull the plug, never the cable.

1) Plug one end of the AC power cord into the **POWER** connector on the bottom of each speaker, then plug the other end to an AC (mains) outlet.

→ The primary speaker will automatically power on and the touch screen will turn on.

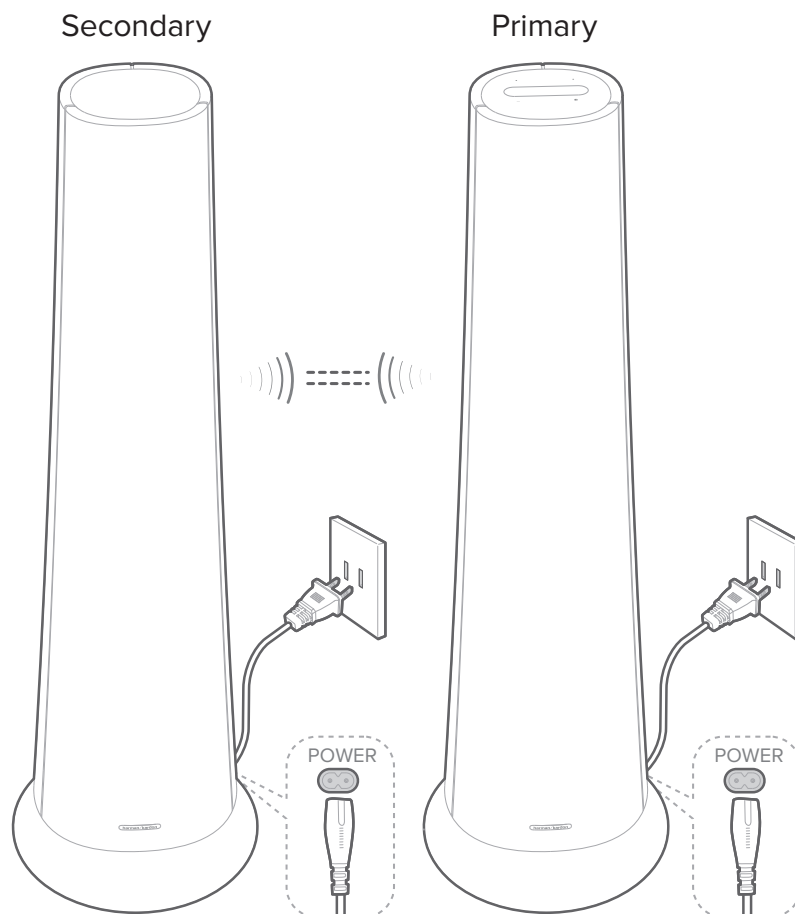

- 2) Select your language as instructed on the touch screen of the primary speaker for the first-time setting.

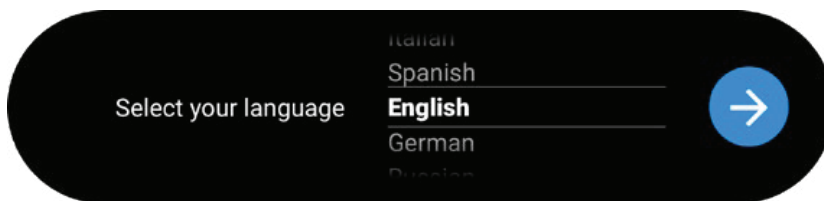

- 3) Press “**MUSIC**” to operate as standalone stereo speakers or “**VIDEO**” to operate as a pair of satellite speakers (See the “**SPEAKER SETUP**” section for details).

/ SPEAKER SETUP

Operate as Standalone Stereo Speakers

- 1) Press “**MUSIC**” on the touch screen of the primary speaker to enter stereo mode. Your CITATION TOWER is required to connect Wi-Fi with the Google Home app.
- 2) Download the Google Home app on your smartphone or tablet.

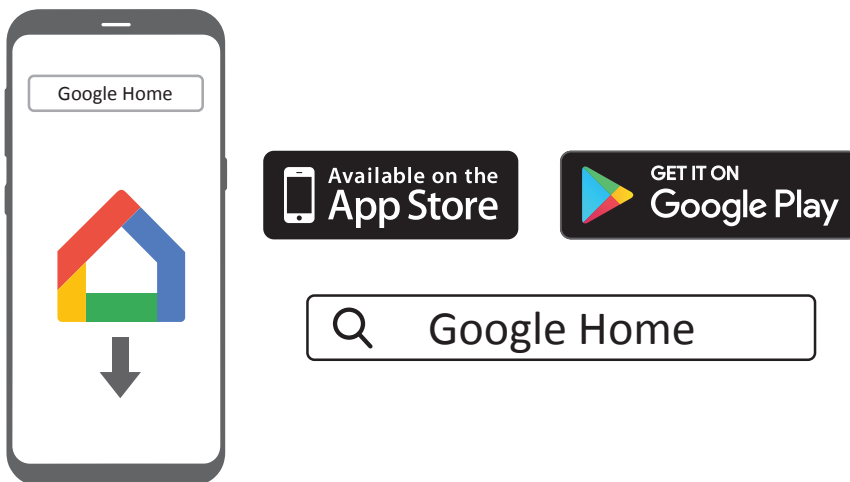

- 3) Run the Google Home app and set up your CITATION TOWER as instructed in the app. Always follow the instructions in the app to complete the Wi-Fi setup.
- 4) Sign in with your Google account. If you do not have, create a new one.

NOTES:

- If you encounter any setup issues, make sure to enable Bluetooth and location services on your smartphone or tablet.
- In the Google Home app, you can rename this product. The device name will remain during Bluetooth device discovery and Chromecast streaming.
- Once this product is connected to the Internet, it will receive a periodic over-the-air software update to improve performance. This update may take a few minutes to complete.

Operate as Satellite Speakers

You can operate your CITATION TOWER as a pair of satellite speakers with:

- CITATION BAR (sold separately): to set up a 3.0 channel surround sound system.
 - CITATION ADAPT (sold separately): to set up a 2.0 channel sound system for TV use case.
- 1) Press **“VIDEO”** on the touch screen of the primary speaker to enter surround mode. Your CITATION TOWER will become a pair of wireless satellite speaker for CITATION BAR / ADAPT (sold separately).
 - 2) Follow the on-screen instructions on your CITATION BAR / ADAPT to complete the setup.

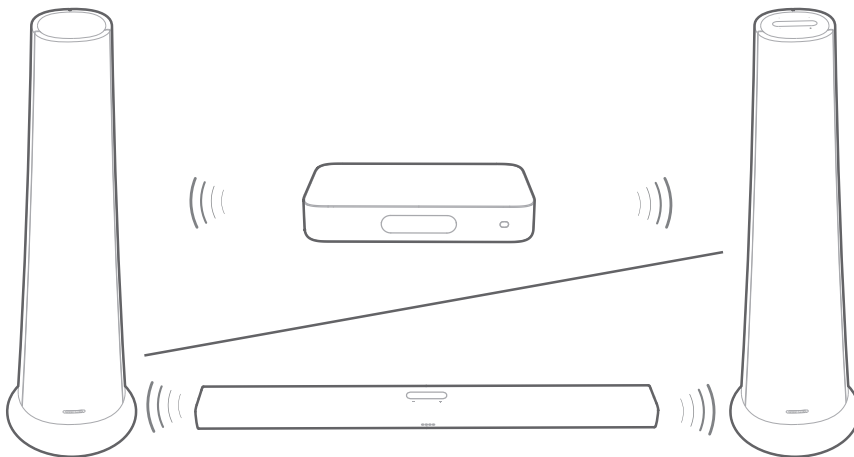

Pair with CITATION SUB (Optional)

To enhance the bass performance, you can wirelessly pair your CITATION TOWER with CITATION SUB (wireless subwoofer, sold separately).



NOTES:

- For a successful setup, keep a maximum distance of 5 meters (16.4 feet) between the Citation Tower and your Citation Sub.
- If CITATION TOWER is powered off, the subwoofer will enter standby mode.
- If you use a device near your CITATION TOWER and both use the same frequency (2.4GHz or 5GHz), interference may cause some sound interruption.
- The maximum transmission distance of the wireless signal between CITATION TOWER and the subwoofer may vary depending on your operating environment.

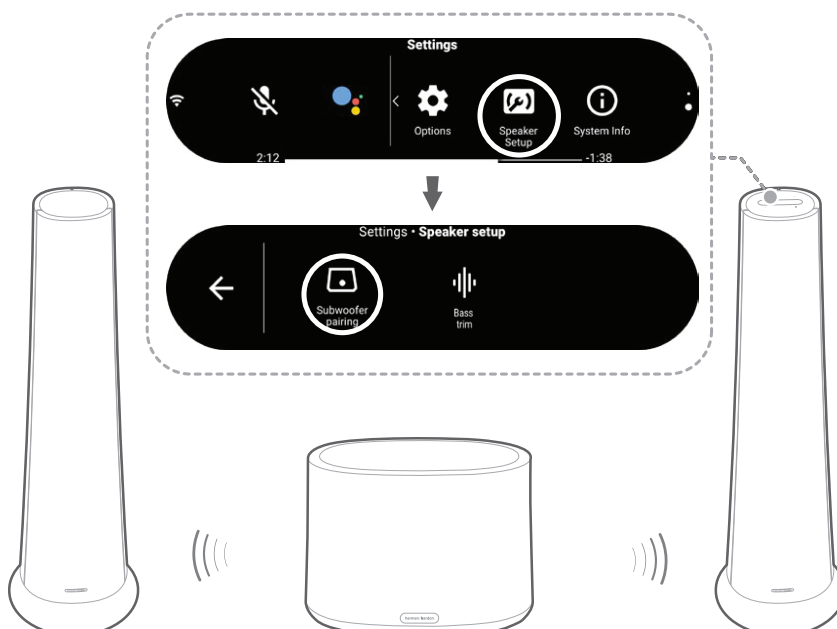
- 1) Power on both CITATION TOWER and CITATION SUB.
- 2) Press **“Speaker Setup”** > **“Pairing”** > **“Subwoofer pairing”** on the touch screen to enter pairing mode.
 - You will hear a pairing chime once successfully connected and **“Subwoofer connected”** will be displayed on the touch screen.



LED Indicator (CITATION SUB)

	White (Flashing)	Pairing
	White (Flashing)	Out of range / Lost wireless connection
	White (Constant for 10 seconds and then light off)	Wirelessly connected with CITATION TOWER

/ USING YOUR CITATION TOWER

Talk to Google Assistant

Your CITATION TOWER comes with the Google Assistant built-in. You can play music, get the answer, manage everyday tasks, and easily control smart devices around your home by using your voice.

Press  on the touch screen of the primary speaker to activate the Google Assistant and then say your request.

When the CITATION TOWER is streaming music through Chromecast or Bluetooth, you can say the wake word “**Ok Google**” or “**Hey Google**” first and then your request.

→ CITATION TOWER will respond instantly.

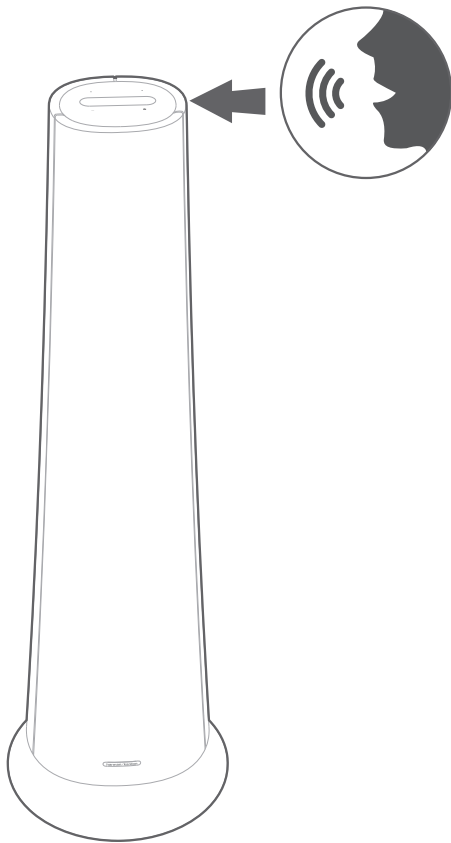

NOTE:

- For the latest voice commands, please visit assistant.google.com.

Play Music with Chromecast

With Chromecast built-in, you can stream music / tunes / podcasts / playlists from 300+ music apps to your speaker by simply tapping the **Cast** button.

- 1) Run the Chromecast enabled app on your smartphone or tablet.
- 2) Press the  icon in the app and select the CITATION TOWER.
- 3) Press “**Play**” in the app.

NOTES:

- The name of this product is assigned during the Wi-Fi setup.
- The Citation speaker can support audio streaming but not video streaming.

Multi-room Group Playback with Citation Family

Citation speaker can support multi-room control provided by Chromecast built-in.

In the Google Home app, simply create a group, add your speakers together and then you have multi-room playability.

NOTES:

- Refer to Google Home app for more details.
- The amount of Chromecast speakers you can stream music to depends on the bandwidth of your local wireless network. Theoretically, an unlimited amount of devices can be connected to stream the same song.

Play Music through Bluetooth

You can use your CITATION TOWER as a speaker for your Bluetooth enabled smartphone or tablet.

- 1) Press  **Bluetooth** on the touch screen to enter Bluetooth pairing mode.

→ During the 10 seconds of reconnection period, or until a successful connection, the white circle below  icon will blink.





- 2) On your smartphone or tablet, select “**Citation Tower**” to connect. You will hear a pairing chime once connected.
 - When the music is playing, the track, title and artist of the song will scroll on the touch screen.

NOTES:

- If you have already connected the soundbar to Wi-Fi and changed the device name, then select the new device name.
- To disconnect and pair another device, press and hold  **Bluetooth** for more than 3 seconds on the touch screen.
- The speaker automatically turns off after 20 minutes of inactivity.
- Bluetooth performance can be affected by the distance between this product and your Bluetooth device and the environment of operation.
- Keep a maximum distance of 10 meters (33 feet) between this product and your Bluetooth device to avoid disconnection.

Playback Controls

- : Start, pause or resume play.
-  / : Skip to previous / next track.

/ SETTINGS

Volume

You have four ways to adjust the volume level while playing music.

- Press or press and hold - / + button on the top panel.
- Softly drag the volume bar.
- Adjust the volume via the Google Home app on your smartphone or tablet.
- Ask Google Assistant to adjust the volume by your voice.

Display Brightness

Press **Options** > **Brightness**, then softly drag the value bar to adjust the brightness of the touch screen.

Software Upgrade

The software of your CITATION TOWER will be automatically upgraded to the latest version when it is connected to the Internet via a Wi-Fi network.

Restore Factory Settings

To restore the default settings programmed at the factory:

- Press “**Options**” > “**Factory Reset**” on the touch screen;
or
- Press and hold the **RESET** button on the bottom of the primary speaker for 5 seconds.

When the factory settings restore is complete, the Citation speaker will automatically power off and restart. Any stored information or settings will be erased.

System Information

Press “**System info**” on the touch screen to view the system information:

- **Country:** Country and language.
- **Network:** Network SSID, signal strength and Wi-Fi address.
- **About:** Model and name.
- **Software version:** Software version and date of last update.

Cleaning and Maintenance

To keep the exterior surface of your speaker clean, unplug the AC power cord from the speaker first, wipe the exterior surfaces gently with a clean, soft cloth.

NOTE:

- Do not use alcohol, benzene, or thinner to clean the fabric surface.

/ SPECIFICATIONS

- Transducer: 1 x 25mm tweeter, 2 x 4" woofer, 1 x 8" subwoofer per speaker
- Output power: 200W RMS per speaker
- Power Supply: 100-240V – 50/60Hz
- Wi-Fi network: 802.11b/g/n/ac (2.4GHz/5GHz)
- Power consumption in sleep mode: <2.0Watts
- Bluetooth® version: 4.2
- Bluetooth transmitter frequency range: 2402 – 2480MHz
- Bluetooth transmitter power: <8dBm (EIRP)
- Bluetooth transmitter modulation: GFSK, $\pi/4$ DQPSK, 8DPSK
- 5GWi-Fi transmitter frequency range: 5.15GHz - 5.35GHz, 5.47~5.725 GHz, 5.725~5.825GHz
- 5GWi-Fi transmitter power: <20dBm (EIRP)
- 5GWi-Fi modulation: OFDM, BPSK, QPSK, 16QAM, 64QAM, 256QAM
- 2.4GWi-Fi transmitter frequency range: 2412 – 2472MHz (2.4GHz ISM Band, USA 11 Channels, Europe and others 13 Channels)
- 2.4GWi-Fi transmitter power: <20dBm (EIRP)
- 2.4GWi-Fi modulation: OFDM, DSSS, DBPSK, DQPSK, CCK, 16QAM, 64QAM
- 5GWISA transmitter power: <14dBm (EIRP)
- 5G WISA modulation: OFDM, BPSK, QPSK, 16QAM
- 5GWISA transmitter frequency range (varies by country or region): 5.15 - 5.35GHz, 5.470 - 5.725GHz, 5.725 - 5.825GHz
- Supported audio formats: HE-AAC, LC-AAC, MP3, Vorbis, WAV (LPCM), FLAC, Opus
- Dimensions (W x H x D): 347 x 1160 x 347 mm / 13.7" x 45.7" x 13.7" per speaker
- Weight: 19.4 kg / 42.8 lbs per speaker

/ TROUBLESHOOTING

Never try to repair the product yourself. If you have any problems using this product, check the following points before you request service.

Sound

No sound from the speaker.

- Make sure that the speaker is not muted.
- Make sure to select the correct audio input source.

No sound from CITATION SUB.

- Check if the subwoofer LED is in solid white color. Blinking LED means a disconnection. Manually pair them with the soundbar.

Bluetooth

A device cannot connect with the speaker.

- Check if you enable the Bluetooth function of the device.
- The speaker is already connected to another Bluetooth device. Press and hold **Bluetooth** on the touch screen to disconnect and pair with a new device.

Poor audio quality from a connected Bluetooth device.

- The Bluetooth reception is poor. Move the device closer to the speaker, or remove any obstacle between your device and the speaker.

Wi-Fi

Failed to connect to Wi-Fi.

- Make sure that Wi-Fi is turned on.
- Make sure that you have selected the right network and entered the correct password.

- Make sure that your router or modem is turned on and within the range.
- Make sure that your CITATION speaker is connected to the same wireless LAN as your smartphone or tablet.

The Google Home app cannot find the device.

- Make sure that your CITATION speaker is powered on.
- Make sure that your network is working properly.
- Make sure that your router or modem is powered on and within the range.

No response to the voice command.

- Depending on the location of your CITATION speaker, the ambient conditions may prevent the CITATION from detecting the voice command “**OK Google**”. Avoid placing the CITATION in a noisy place or a place that is exposed to strong winds or echoes (sound reflections).
- Make sure that the built-in microphones are not muted.

/ TRADEMARKS



The Bluetooth® word mark and logos are registered trademarks owned by the Bluetooth SIG, Inc. and any use of such marks by HARMAN International Industries, Incorporated is under license. Other trademarks and trade names are those of their respective owners.



The Wi-Fi CERTIFIED Logo is a certification mark of the Wi-Fi Alliance..



Google, Google Play, Chromecast and other related marks are trademarks of Google LLC. Chromecast built-in may require subscription(s). The Google Assistant requires an internet connection and is not available in certain countries and languages. Availability and react of certain features and services are device, service and network-dependent and may not be available in all areas. Controlling certain devices in your home requires compatible smart devices. Subscriptions for services and applications may be required and additional terms, conditions and/or charges may apply.

harman / kardon[®]
by HARMAN