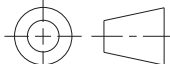

01  
变更符号

REVISIONS (试产: P/量产: V)				
REV	ZONE	DESCRIPTIONS	AUTHCR	DATE
A		首次发行	邓娟	2021.06.23

材质: 封面、封底250g哑粉纸, 内页105g哑粉纸  
 印刷颜色: PANTONE Cool Gray 8C  
 尺寸: 190\*120mm  
 工艺: 封面、封底覆膜, 内页过油, 胶装

707-00333-001		WWAM01项目-说明书			
PART NUMBER		Name OF BOM		REMARK	
THIS DOCUMENT CONTAINS PROPRIETARY INFORMATION AND SHALL NOT BE DUPLICATED OR DISCLOSED TO OTHERS WITHOUT PERMISSION				PRODUCTION	
Designer:	F-check:	STD-check:	DRAWING FILE NAME		
邓娟			MODEL NAME		
OPT-check:	Approve I:	Approve II:	ISSUED DATE	DRAWING REVISION	TOOLING VERSION
				A	
		SIZE A4	SHEET COVER OF 1		SCALE UNIT mm

# XGIMI AURA

## USER GUIDE

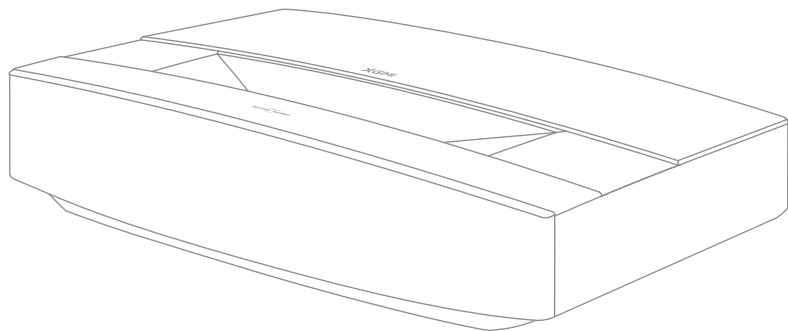



English	1
Deutsch	22
Español	43
Français	64
Italiano	85
Polskie	106
Português	127
Русский	148
日本語	170
繁体中文	191
한국어	212
اللغة العربية	233



## Please read the Product Instructions carefully before using the product

Thank you for purchasing and using the products of Chengdu XGIMI Technology Co., Ltd. (hereinafter referred to as "XGIMI Technology" or "XGIMI"). You should read the Product Instructions carefully before using this product for both your safety and interests. XGIMI Technology disclaims all responsibilities for any personal injury, damage to property, or other loss that may occur as a result of improper or unsafe use of this product.

## About the Product Instructions (hereinafter referred to as the "Instructions")

The copyright of the Instructions belongs to XGIMI Technology.

Trademarks and names mentioned in the Instructions belong to their respective right owners.

In case of inconformity between the content of the Instructions and the actual product, the actual product shall prevail.

Any objections to any content or clause found within the Instructions should be reported to XGIMI Technology in written form within 7 days after the purchase; otherwise, it will be assumed that you agree to, understand, and accept all the content of the Instructions.

Google, Android TV and Chromecast built-in are trademarks of Google LLC.

Google Assistant is not available in certain languages and countries. Availability of services varies by country and language.



High-Definition Multimedia Interface (HDMI) and the HDMI Logo are trademarks or registered trademarks of HDMI Licensing Administrator, Inc.



For DTS patents, see <http://patents.dts.com>. Manufactured under license from DTS Licensing Limited. DTS, DTS-HD, DTS Studio Sound, and the DTS-HD logo are registered trademarks or trademarks of DTS, Inc. in the United States and other countries. © 2020 DTS, Inc. ALL RIGHTS RESERVED.



Manufactured under license from Dolby Laboratories. Dolby, Dolby Audio, and the double-D symbol are trademarks of Dolby Laboratories Licensing Corporation.

\* Model: XM03A

\* XGIMI Technology reserves the right to interpret and amend the Instructions.

## What's Included

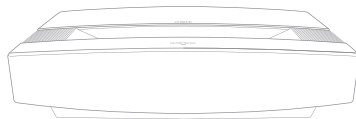

XGIMI AURA



Power cord



Remote Control



Instruction Manual



Warranty Card

Note: Please keep the original package in case of needed transportation in the future. To protect the product, please wrap it how it was received.

# Overview

## Front & Top View

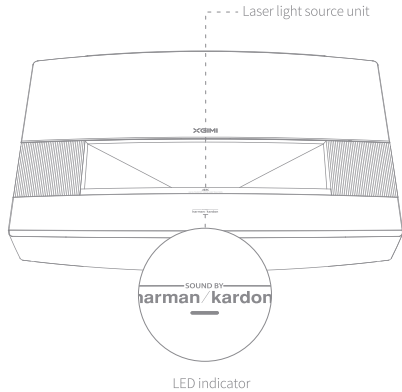

	LED Status	Description
1.	Orange Light Steady-on for several seconds	The device is powered on after plugging in the power cord.
2.	White Light Flashing	The device is powering on/off.
3.	White Light Steady-on	The device is powered on with the "Display Off".
4.	Orange Light Blinking	The firmware is updating.



## Side View (right)

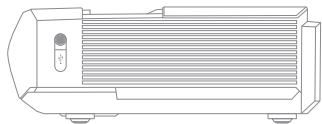

Power button

USB 2.0

## Rear View

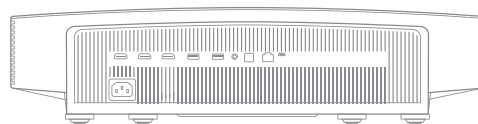

HDMI 1/ARC



HDMI 2



HDMI 3



USB 2.0



USB 2.0



AUDIO



OPTICAL



LAN



SERVICE

Note: Use HDMI 2.0 cables when using HDMI 2.0 interfaces.

## Remote Control

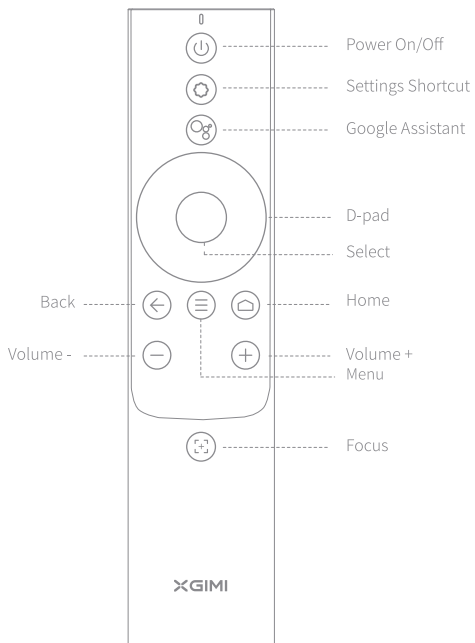

## Getting Started

### 1 Placement

Place the projector on a stable, flat surface and ensure the lens is aligned with the projection plane (display wall/surface). The rear of the projector should be parallel to the projection plane.

To achieve optimal projection, make sure the projection plane is white and flat, or you can use a projector screen. The wall for projection should be larger than the size of your desired image.

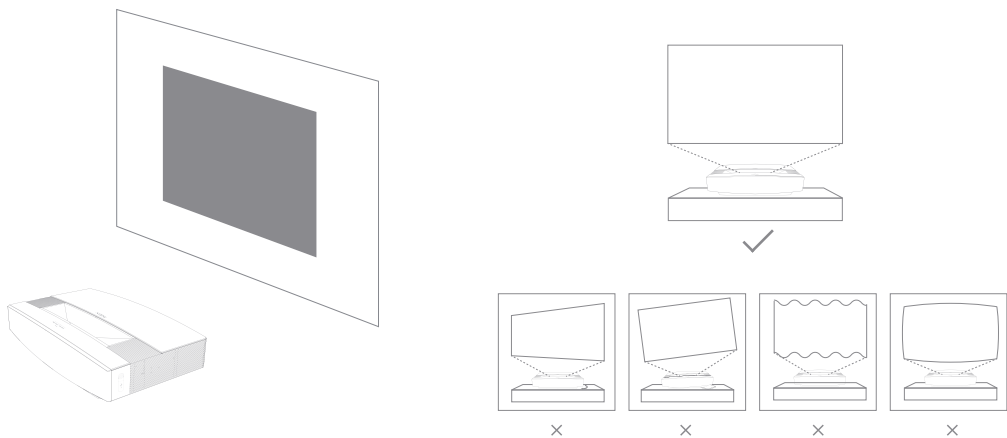

The screen sizes for each projection distance may differ depending on the installation environment.

Unit: cm (inches)

C	X	Y	D	H
80"	177.1 cm (69.7")	99.6 cm (39.2")	10.9 cm (4.3")	32.9 cm (13.0")
90"	199.3cm (78.4")	112.1 cm (44.1")	15.4 cm (6.1")	34.0 cm (13.4")
100"	221.4 cm (87.2")	124.5 cm (49.0")	20.9 cm (8.2")	38.8 cm (15.3")
110"	243.5 cm (95.9")	137.0cm (53.9")	24.7 cm (9.7")	39.5 cm (15.6")
120"	265.7 cm (104.6")	149.4 cm (58.8")	29.8 cm (11.7")	42.0 cm (16.5")
130"	287.8 cm (113.3")	161.9 cm (63.7")	36.1 cm (14.2")	44.3 cm (17.4")
150"	332.1 cm (130.7")	186.8 cm (73.5")	44.1 cm (17.3")	49.3 cm (19.4")

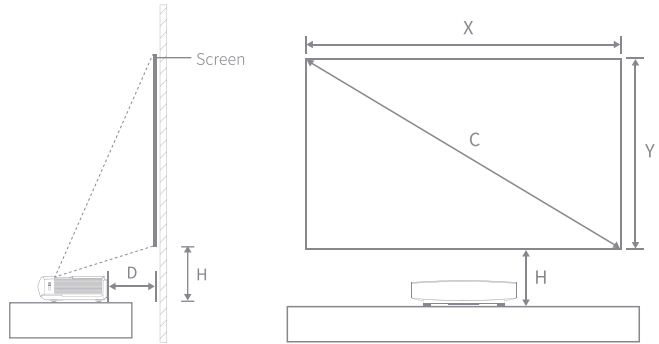

## 2 Using the Remote Control

- 1 Upon the first use, press the battery compartment release button on the back of the remote control to remove the battery compartment. Then, insert two AAA batteries.
- 2 When you insert the batteries, make sure that the + and – symbols on the batteries match the + and – symbols inside the battery compartment, and then press the battery compartment back onto the remote control.  
If you need to replace the batteries later, repeat the directions above.

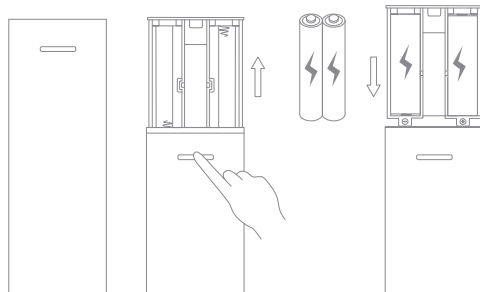

### 3 Powering on the Device

1. Connect the power cord to the XGIMI AURA.

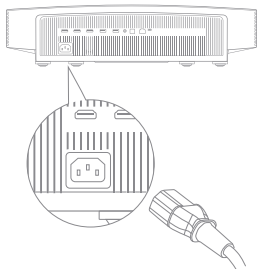

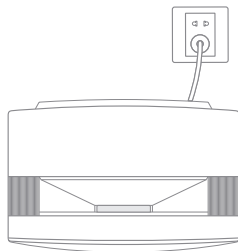

2. Connect the power cord to the power socket.

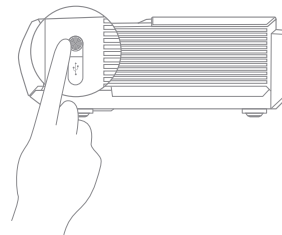

3. Press the power button to turn on the device.



#### 4 Pairing the Remote Control

Ensure the remote control is within 10 cm of the device, press  and  simultaneously until the indicator light begins flashing. This means that the remote control has entered pairing mode. When you hear a "Ding", the connection is successful.

If pairing fails, the remote control will exit pairing mode after 30 seconds. Repeat the above steps after exiting.

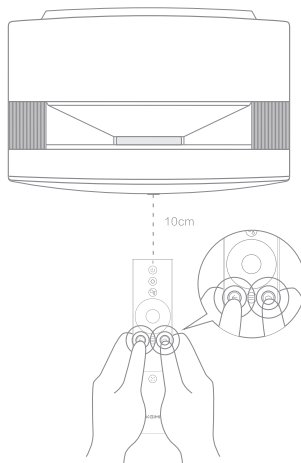

## 5 Adjusting the Focus

Press the  button to enable manual focus adjustment. You can manually adjust the focus by pressing the "left/right" button or the "VOL+/-" button. After adjusting, you can press any other button to exit.

## 6 Setting Up Android TV

After the remote control is paired, follow the onscreen instructions to complete the Android TV setup.

### 1 Quick Setup (Android)

Android users can follow the onscreen instructions to quickly set up Android TV with their smartphones.

### 2 Set up XGIMI AURA (iOS)

For iOS users, follow the instructions below to complete the setup:

1. Skip the quick setup process.
2. Connect XGIMI AURA to your network.
3. Log in with your Google account.

Your XGIMI AURA will be powered by Android TV after the setup process is complete.

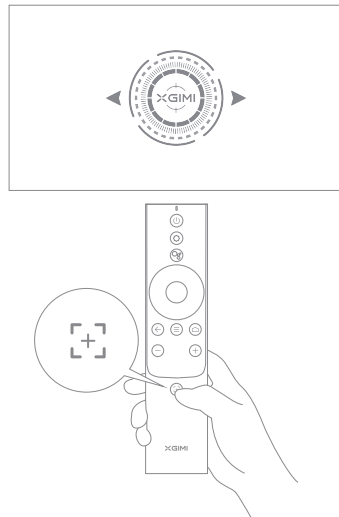



## 7 Adjusting the Projection Picture

Adjust the picture angle by moving the projector left or right or by altering the tilt angle adjustment foot at the bottom to make the screen rectangular.

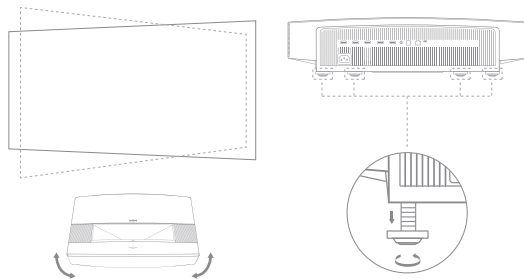

If you still think the projection picture is not square enough, use the remote control to open [Settings], select [Projector Settings] -> [Keystone Correction] -> [Manual Keystone Correction], and then choose the adjustment points to alter the projection picture further.

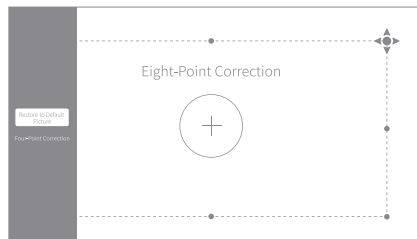

Manually adjust the projection picture by using one of the following two methods:

Four-point correction: Manually correct the projection picture by adjusting the 4 points. Press OK to switch adjustment points.

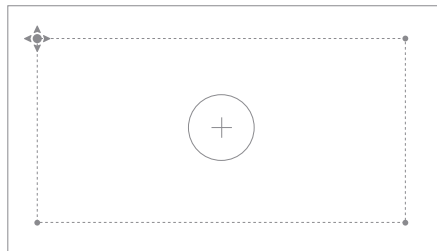

Four-Point Correction

Eight-point correction: A better way to fine-tune the projection picture compared to four-point correction. Apart from the adjustment points 1, 3, 5, 7, you can alter the edge of the image by adjusting points 2, 4, 6, 8.

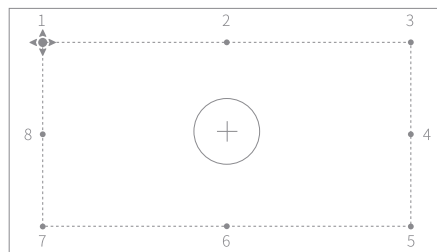

Eight-Point Correction

## Using XGIMI AURA

### 1 Android TV Features

After the projector is connected to a wireless network, you can access Android TV online services and enjoy movies, music, and pictures. In addition to the pre-installed apps, you can also install other apps from the Google Play store and ask Google Assistant to help via various voice commands.

Press the Google Assistant button on your remote to search for movies and shows, get recommendations and answers, control smart home devices, and more.

You can project photos, videos, and music from your smartphone or PC directly to your projector.

- 1 Play a video clip with a smartphone or PC app that supports Chromecast built-in™, and then select  on the screen.
- 2 Select the target device, "XGIMI AURA", to begin projecting your smartphone content.

Note: Make sure the projector and your smartphone or PC are connected to the same network.

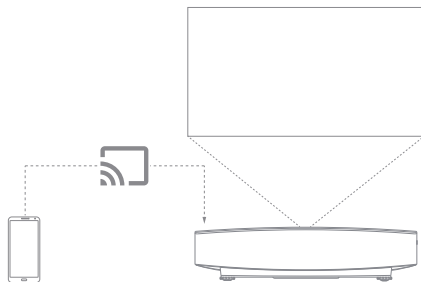

## 2 Bluetooth

### Connect a Bluetooth speaker

- 1 Open [System Settings] -> [Remotes & Accessories] -> [Add New Device].
- 2 Search for and pair with a Bluetooth speaker.  
To switch back to the projector speaker while the Bluetooth speaker is connected, press , and then select [Sound Output] -> [Internal Speaker]

### Play music via Bluetooth

Use smartphone Bluetooth settings to search for "XGIMI AURA" to pair with the device and play songs.

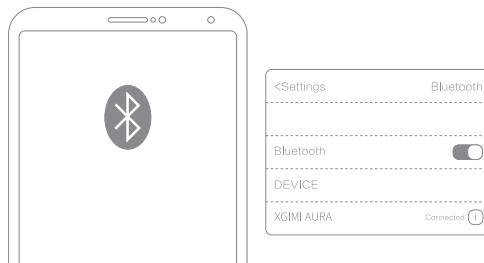

## 3 XGIMI Apps

### XMusic Player

XMusic Player is a built-in music player for XGIMI AURA and can play local music or music via Bluetooth. In the XMusic Player app, you can select different playback wallpapers to achieve an immersive listening experience.

If you need to turn off the projection frame during music playback, you can press the  button and select "Display Off".

Bluetooth music: When your smartphone Bluetooth is connected to XGIMI AURA, the XMusic Player app will open automatically. You can also select  on the homepage to go to the app list and open the app.

Local music: You can access an internal or external storage device using the built-in app File Manager. Open a music file, and it will play on the XMusic Player app by default.

Note: Some wallpapers may contain flashing lights and spectrums that may trigger epileptic seizures. If you experience dizziness, convulsions, or vision changes, switch the wallpaper to "Classic CD" and seek medical attention.

## File Manager

Use the File Manager app to view files on the device storage or external storage.

- 1 On the home page, click  Apps to open the app list. Select File Manager, and then select the device storage or external storage device.
- 2 Press and hold on to the "Settings" button to manage files. Press the "Menu" button for more actions.

Note: According to Android TV security requirements, you can only read files from external storage devices but cannot copy and paste these files.

## 4 Settings

At any interface, you can press the  button on the remote control to quickly adjust settings on your device. To configure more settings, go to the [All Settings] page.

The main settings include:

### Brightness and Color

Select a brightness mode, such as standard, bright, eye-protection, and adjust the brightness level. To customize the brightness and color of the picture, you can select "Custom mode".

- Standard: Used when watching films.
- Bright: Brighter than Standard mode.
- Eye-protection: Reduced blue light, preventing eye fatigue or strain.
- Performance: Recommended when you highly demand brightness.
- Custom: Customize the RGB value and 10-class brightness level.

### Image Mode

When watching content via HDMI or watching videos, select different image modes for different scenarios, such as movie, football, office, and game, to enjoy the optimal viewing experience.

- Movie: Ideal for watching films or TV series thanks to its cinematic picture quality.
- Football: Ideal for watching football games.
- Office: Ideal for office use.
- Game: Ideal for playing video games thanks to its low latency rates.
- Custom: Customize image parameters such as contrast, saturation, sharpness, noise reduction level, and motion compensation level.

### Sound Effect

XGIMI AURA offers you professional sound quality with DTS Studio Sound and Harman Kardon. Select different sound effects for different scenarios, such as movie, music, and sport, to enjoy the optimal sound experience.

## 5 System Upgrade

Check for the latest version and upgrade the system by selecting [Settings] -> [Device Preferences] -> [About] -> [System Update].

## Important Precautions

### Correct use of the device:

- Do not face lens into eyes because the strong projector light may cause injury to the eyes.
- Do not block the air inlet/outlet of the device in order to avoid damage to internal electronic devices arising from normal heat dissipation failure of the device.
- Do not wipe the lens directly with cleaning tools including paper and cloth in order to avoid damage to the lens. Please clean up the dust on the lens surface through clean air blowing.
- Do not wash the device with chemicals, detergents, or any liquid in order to prevent the circuit board from being corroded by rainwater, moisture, and mineral-containing liquids.
- Keep the device and its components and accessories out of reach of children.
- Make sure that the device is used in a dry and ventilated environment.
- Do not store the device in overheated or overcooled places, because extreme temperatures will shorten the life of electronic devices. Place and use the device in an environment of 0°C-40°C.
- Do not put the device into any heating equipment (such as dryer and microwave oven) for drying.
- Do not firmly extrude the device or place barriers on it or its back to avoid damage to the device.
- Do not throw, strike, or sharply vibrate the device to avoid damage to the internal circuit board.
- Do not try to disassemble and assemble the device yourself. If any issue occurs, please contact the after-sales service of XGIMI.
- Do not repair any product on your own. If the device or any component cannot work properly, consult the after-sales service of XGIMI in a timely manner or return it to the factory for repair.

## FCC warning

The device meets provisions of part 15 of FCC rule. Operation meets the following 2 conditions:

- (1) the device will not cause harmful interference, and
- (2) the device must accept any interference received, including interference that may result in accidental operations. User manual or operating instructions shall remind users that intentional or unintentional modification and replacement of radiators without explicit approval from the responsible compliance party may prevent the user from operating the device. If the manual is provided in a form other than paper, such as, provided in computer disk through the Internet, then the information required in the section can be included in the manual in the alternative form under the premise that users can have access to the form information.

Notes: the device has been tested to meet restrictions of part 15 of FCC rule on B-class digital device. These restrictions are aimed at providing the effective prevention of harmful interference in a residential installation. If installation and use are not made according to the instructions, the device will generate and radiate radio frequency energy, and may cause harmful interference to radio communication. However, there is no guarantee that interference will not occur in a particular installation. If the device does cause harmful interference to radio or television reception (determined by stopping and starting the device), it is suggested that users should attempt to correct the interference by one or more of the following measures:

- Reposition direction of receiving antenna.
- Increase the distance between the device and the receiver.
- Connect the device into an outlet on a circuit different from that to which the receiver is connected.
- Consult distributors or experienced radio/television technicians to seek help
- This device is acting as a slave and operating in the 2.4 GHz (2402-2480 MHz, 2412-2462 MHz) band or 5 GHz (5.180 GHz-5.240 GHz, 5.260 GHz-5.320 GHz, 5.500 GHz-5.700 GHz, 5.745 GHz-5.825 GHz) band.



## CE Maintenance

1. Use careful with the earphone maybe excessive sound pressure from earphones and headphones can cause hearing loss.
2. The product shall only be connected to a USB interface of version USB2.0.
3. EUT Operating temperature range: 0°C-40°C .
4. Power supply and ADP (rating):  
AC 110 V-240 V, 50-60 Hz, 350W.
5. To prevent possible damage to hearing, do not listen at high volume levels for long periods.
6. The device complies with RF specifications when the device is used at a distance of 20 cm away from your body.



## Declaration of Conformity

Chengdu XGIMI Technology Co., Ltd. hereby declares that this product is in compliance with the essential requirements and other relevant provisions of Directive 2014/53/EU.

This product is allowed to be used in some of EU member states. For example, the device can be used in the following Member States:

Operations in the 5.15-5.25 GHz band are restricted to indoor usage only.

This Frequency applies to the following Member States or the geographical area within a Member State where restrictions on putting into service or requirements for authorisation of use exist.

The appliance coupler is used as disconnect device, the disconnect device shall remain readily operable.

BE	EL	LT	PT
BG	ES	LU	RO
CZ	FR	HU	SI
DK	HR	MT	SK
DE	IT	NL	FI
EE	CY	AT	SE
IE	LV	PL	UK

## IC Warning

This device complies with Industry Canada licence-exempt RSS standard(s). Operation is subject to the following two conditions:

- (1) This device may not cause interference, and
- (2) This device must accept any interference, including interference that may cause undesired operation of the device.

**EAC RoHS CE**

# Radiation Exposure Statement

For remote control, this device complies with FCC and IC radiation exposure limits set forth for an uncontrolled environment.

The transmitter shall not be placed or operated in conjunction with any other antenna or transmitter.

For the laser projector, the device meets FCC and IC radiation exposure limits specified for uncontrolled environments. In the installation and operation of the device, the distance between radiator and body should be at least 20 cm.

Notes: 5150-5250 MHz frequency range is only for indoor use.

This Frequency applies to the following Member States or the geographical area within a Member State where restrictions on putting into service or requirements for authorisation of use exist.

Disposal instructions for used products:



The product is designed and manufactured with high quality materials and components that are recyclable.



This symbol on the product indicates that it is protected under the Directive 2012/19/EU.

## ▲ WARNING

1. Do not open to avoid the risk of electric shock.
2. All of internal check, please contact authorized customer service center.
3. Possibly hazardous optical radiation emitted from this product. Do not stare at operating beam. May be harmful to the eye.

As with any bright source, do not stare into the direct beam, RG2 IEC 62471-5:2015

Complies with 21 CFR 1040.10 and 1040.11 except for conformance with IEC 60825-1 Ed. 3., as described in Laser Notice No. 56, dated May 8, 2019.



IEC 60825-1:2014



- \* Only use attachments/accessories specified or provided by the manufacturer.
- \* Beware that this product may emit harmful light radiation.