

1324015COMUK

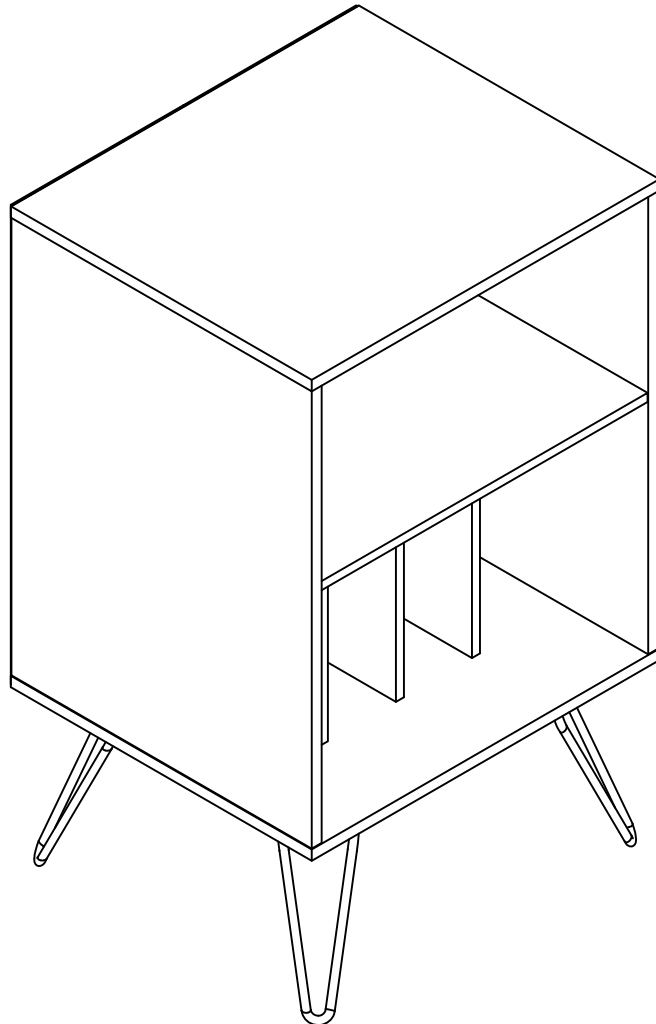

Do Not Return This Product!

Contact our customer service team for help first.

Call: 01942 524100

Visit: CSEurope@dorel.com

Dorel Home Furnishings Europe Ltd.
Building 4, Imperial Place, Maxwell Road
Borehamwood WD6 1JN United Kingdom

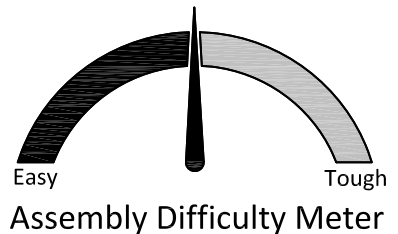

WARNING

- Unit can tip over causing severe injury or death.
- Anchor unit to stud in wall (if instructed to).
- Do Not allow children to climb on unit.
- Put heavy items on lower shelves or drawers.

Helpful Hints

PEOPLE NEEDED FOR ASSEMBLY: **1-2**
ESTIMATED ASSEMBLY TIME: **1 HOUR**

- Open your item in the area you plan to keep it to avoid excessive heavy lifting.
- Identify, sort and count the parts before attempting assembly.
- Compression dowels are lightly tapped in with a hammer.
- Slides are labeled with a **R** (right) and **L** (left) for proper placement.
- Make sure to always face the point on the top of the Cam Lock towards the outer edge.
- Use all the nails provided for the back panel and spread them out equally.
- Back panel must be used to make sure your unit is sturdy.
- Do NOT use harsh chemicals or abrasive cleaners on this item.
- Never push, pull, or drag your furniture.

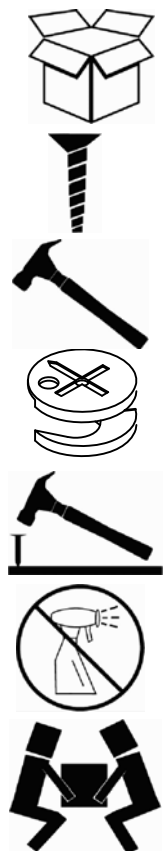

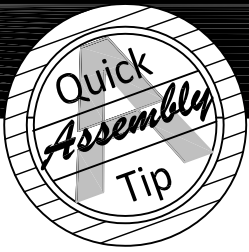

Before You Start

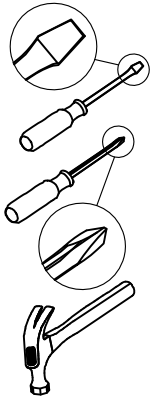

- ✓ Read through each step carefully and follow the proper order
- ✓ Separate and count all your parts and hardware
- ✓ Give yourself enough room for the assembly process
- ✓ Have the following tools: Flat Head Screwdriver, #2 Phillips Head Screwdriver and Hammer
- ✓ Caution: If using a power drill or power screwdriver for screwing, please be aware to slow down and stop when screw is tight. Failure to do so may result in stripping the screw.

Cam Lock Fastening System

This Cam Lock Fastening System will be used throughout the assembly process.

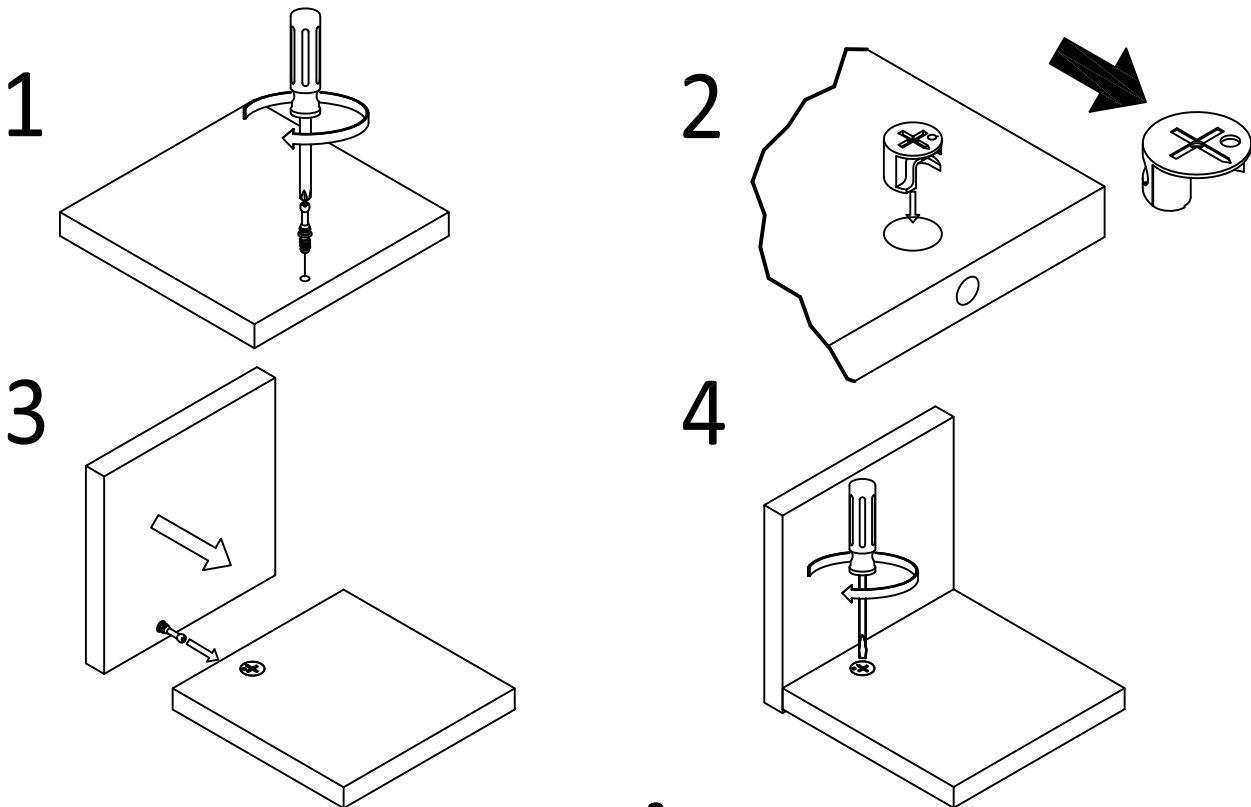

Board Identification

Not actual size

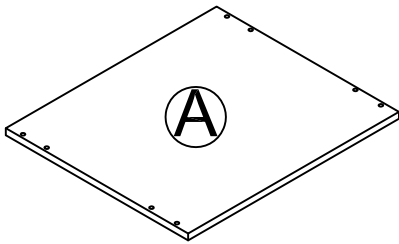

TOP
T1324015010CS

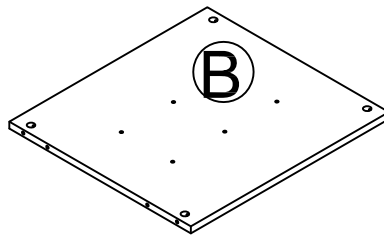

FIXED SHELF
T1324015020CS

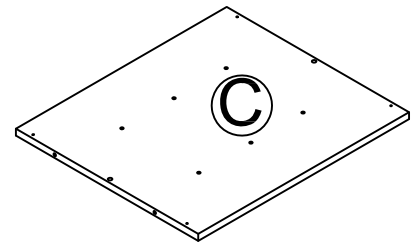

BOTTOM PANEL
T1324015030CS

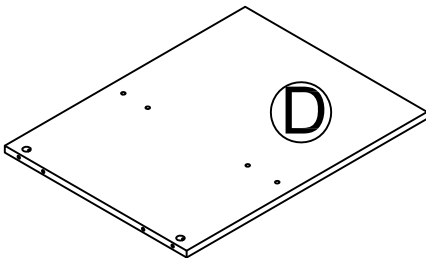

LEFT PANEL
T1324015040CS

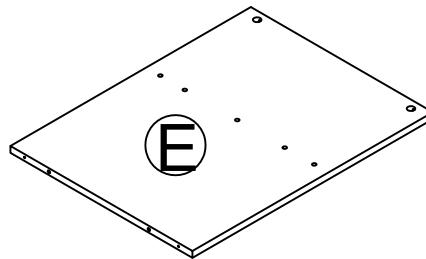

RIGHT PANEL
T1324015050CS

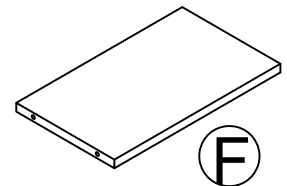

PARTITION
T1324015060CS
QTY:3PCS

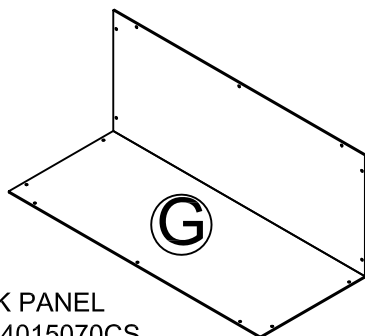

BACK PANEL
T1324015070CS

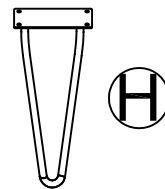

LEG
T1324015080CS
QTY:4PCS

Board Identification

Not actual size

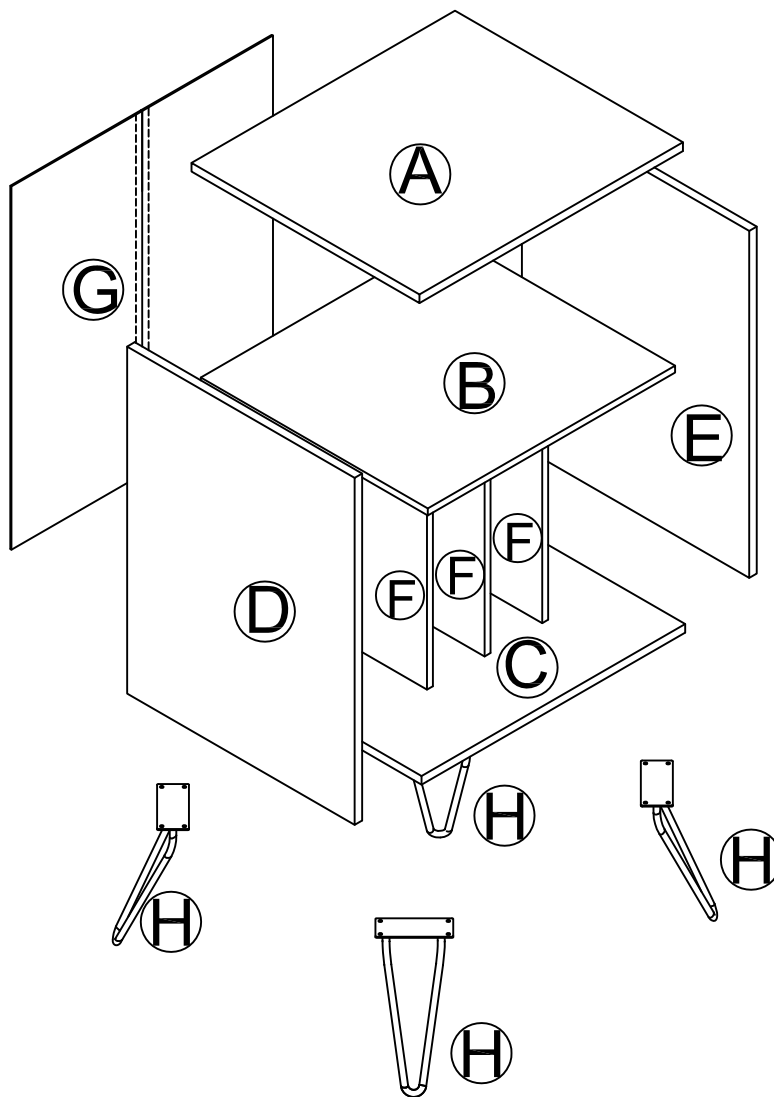

Part List

Actual Size

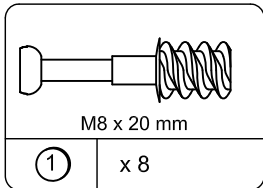

CAM BOLT
TCS2010

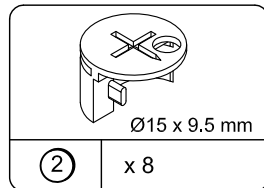

CAM LOCK
TCS2011

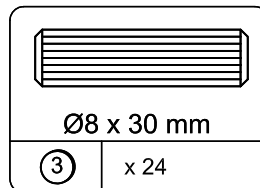

WOOD DOWEL
TCS3002

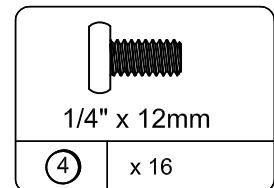

BOLT
TCS1087

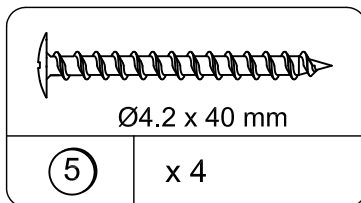

SCREW
TCS1061

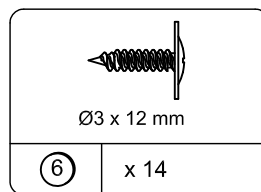

SCREW
TCS1048

Not Actual Size

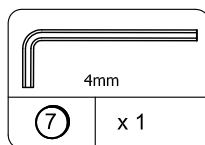

HEX KEY
TCS6001

STEP 1

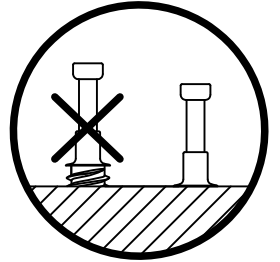
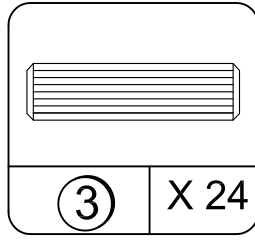
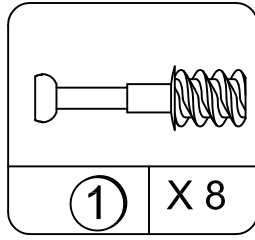
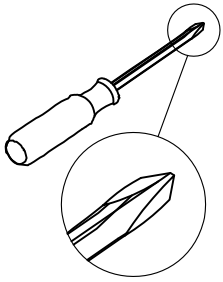

1.1 Screw (1) into (A), (D) & (E) as illustrated.

1.2 Insert (3) into (B), (D), (E) & (F) as illustrated.

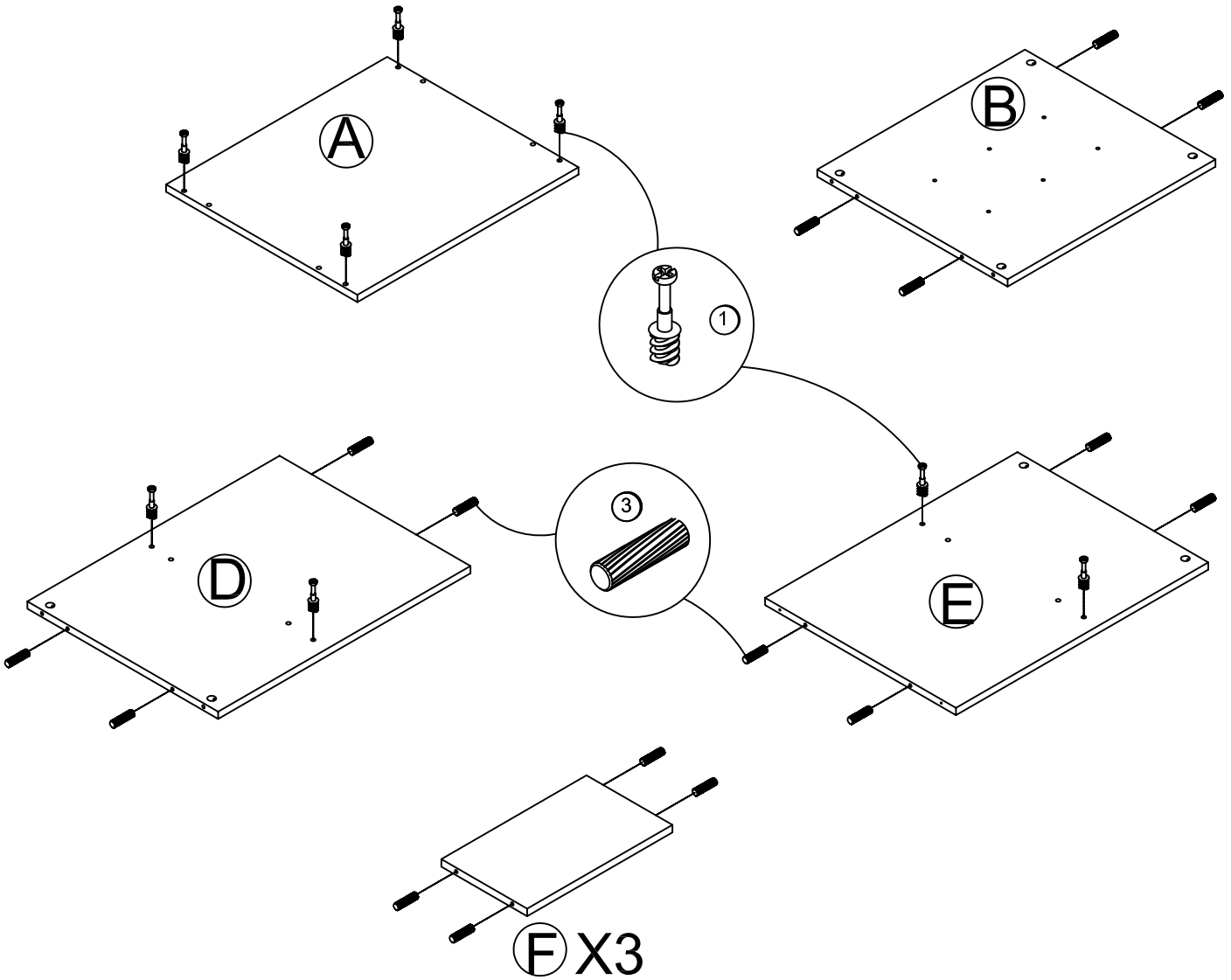

STEP 2

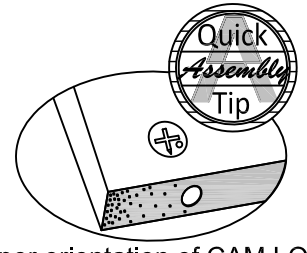
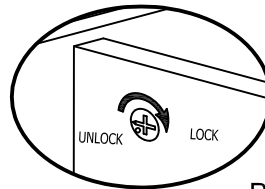
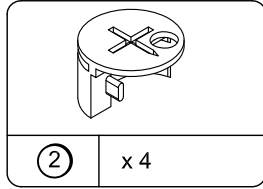
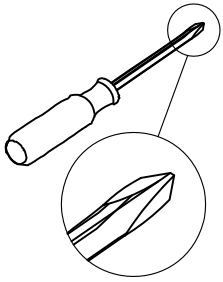

Proper orientation of CAM LOCK

Attach (D) & (E) to (B) with (2) as illustrated.

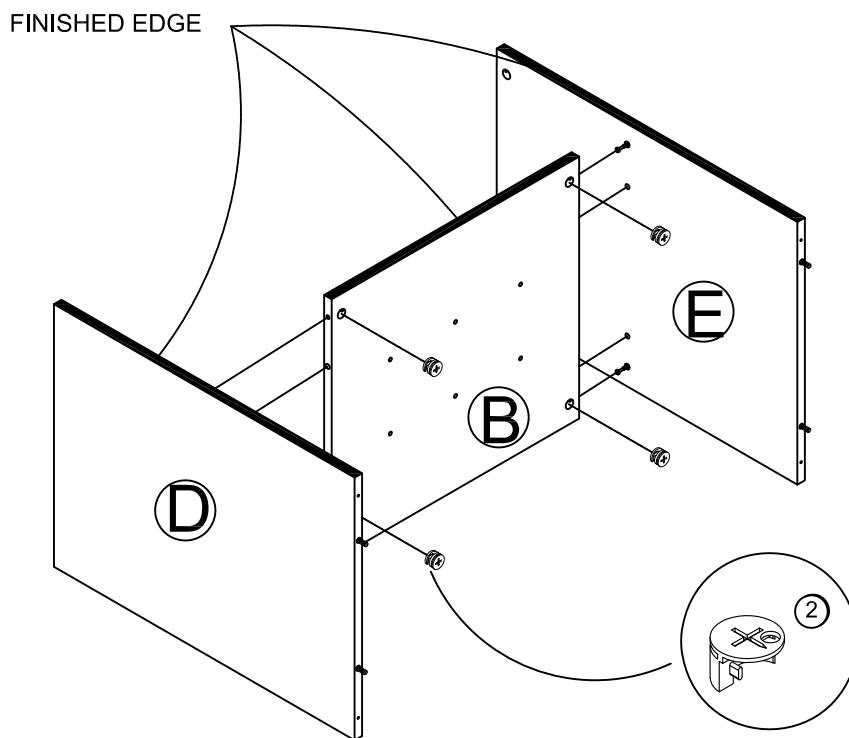

STEP 3

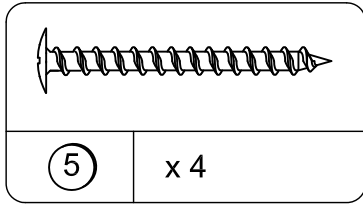
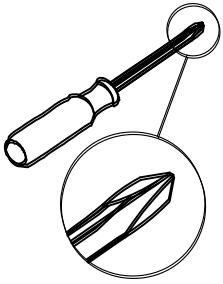

Attach (C) & (F) to sub-assembly **B/D/E** from previous step with (5) as illustrated.

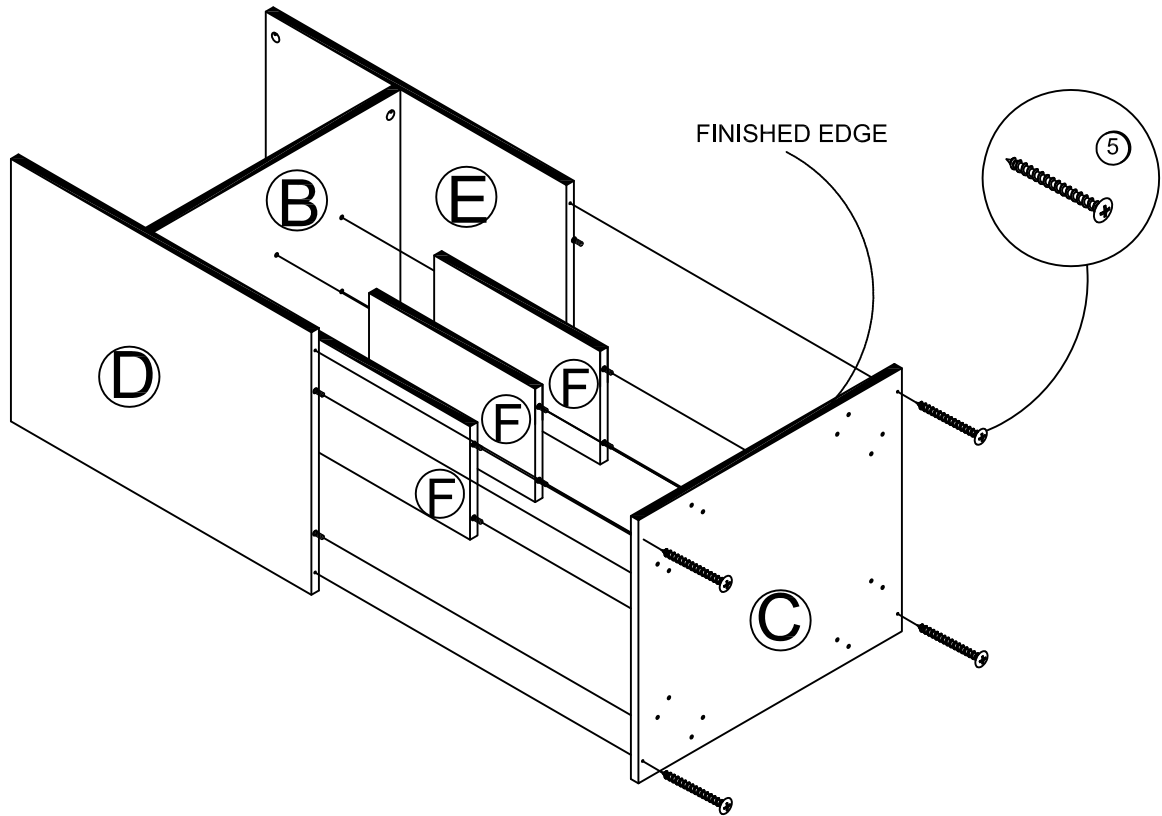

STEP 4

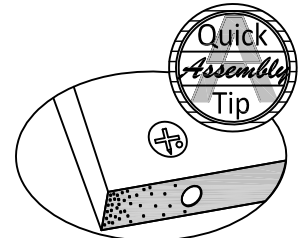
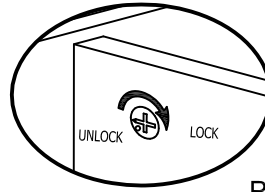
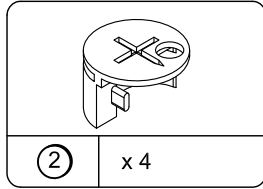
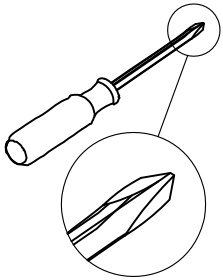

Proper orientation of CAM LOCK

Attach (A) to (D) & (E) with (2) as illustrated.

FINISHED EDGE

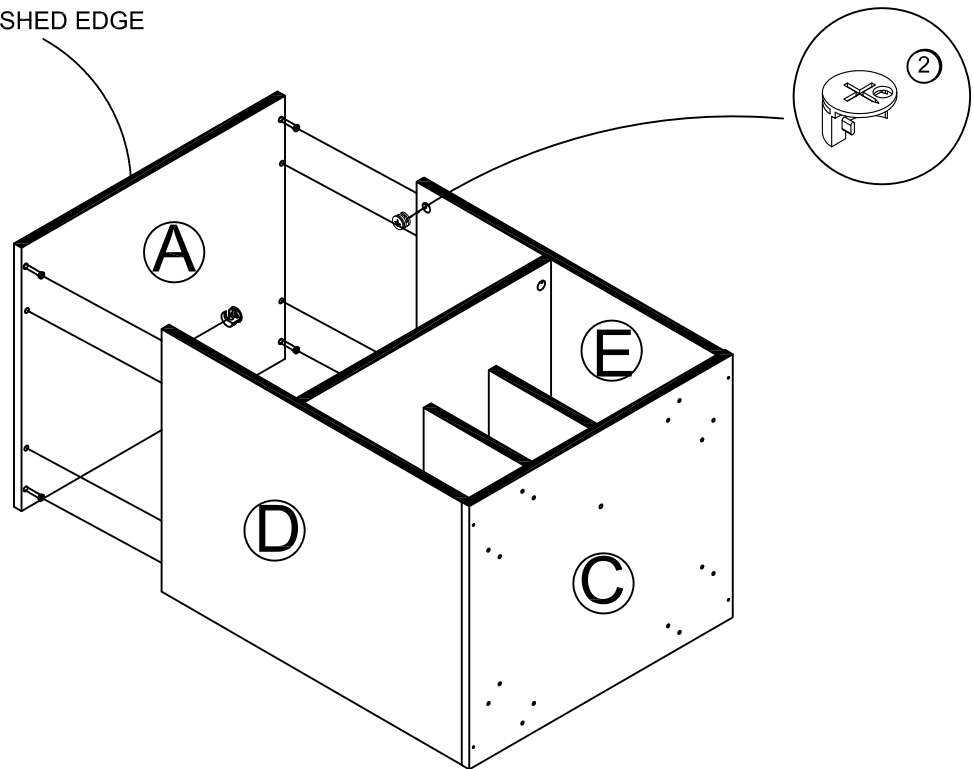

STEP 5

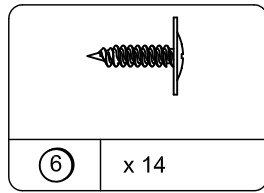
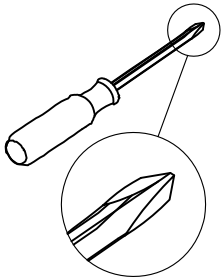

IMPORTANT! THE BACK PANEL IS A STRUCTURAL PART OF THIS UNIT AND MUST BE INSTALLED PROPERLY.

5.1 Turn the assembly over.

5.2 Attach (G) to sub-assembly **A/C/D/E** from previous step with (6) as illustrated. Assure that the unit is square.

Distance from corner to corner must be equal as shown.

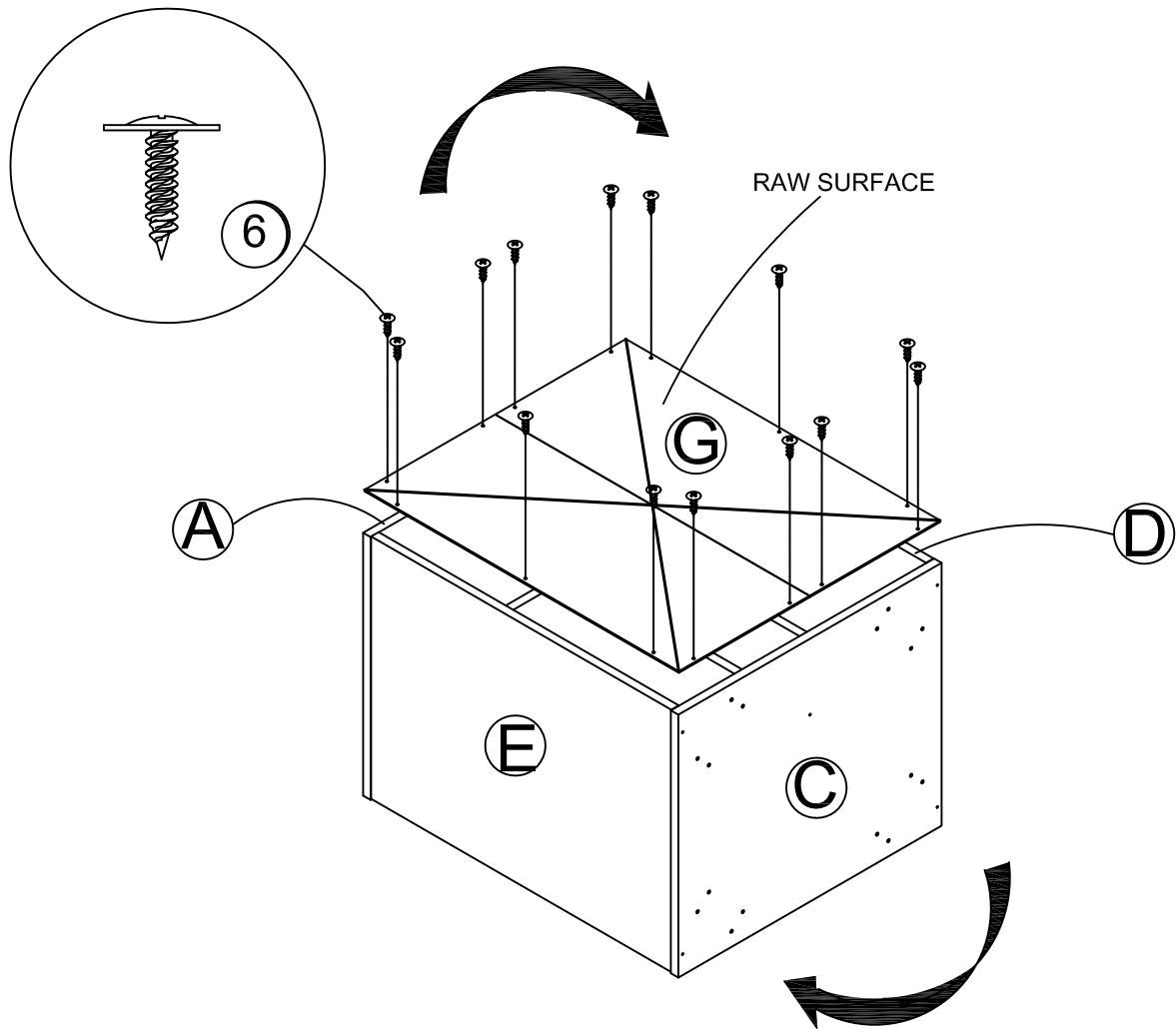

STEP 6

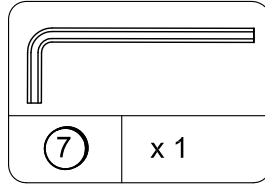
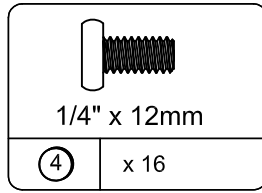
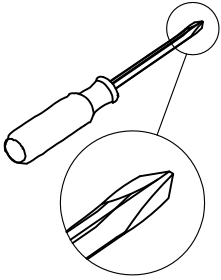

Attach (H) to (C) with (4) as illustrated.

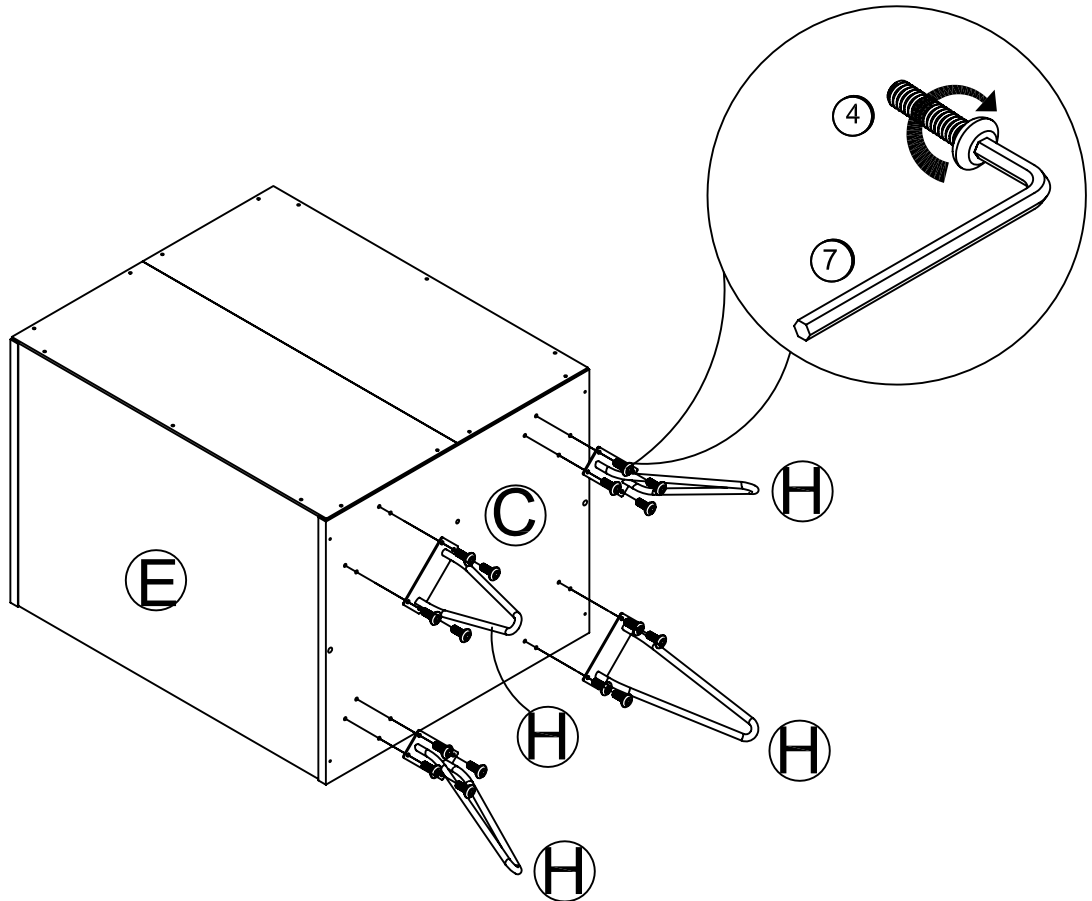

Maximum Loads

This unit has been designed to support the maximum loads shown. Exceeding these load limits could cause sagging, instability, product collapse, and/or serious injury.

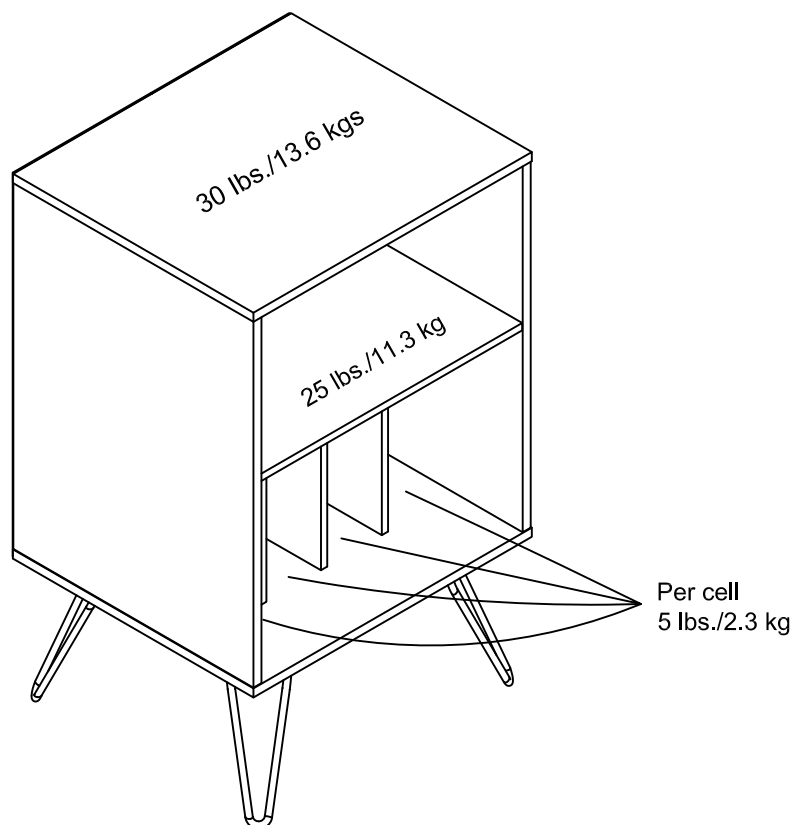

Warning: Risk of injury to persons - do not place a television on this furniture. This furniture is not approved for use with a television.